



CATÁLOGO DE PRODUCTOS 2024



www.tapitex.com



CUENTA BANCO PICHINCHA

NOMBRE: TAPITEX M&B CIA LTDA
CUENTA CORRIENTE #2100015679
RUC: 0190383229001
CORREO: cartera@tapitex.com

CUENTA BANCO PICHINCHA

NOMBRE: IMPORTADORA BALCAZAR GRANJA
CUENTA CORRIENTE #2100304372
RUC: 0190431797001
CORREO: cartera@tapitex.com

CUENTA BANCO GUAYAQUIL

NOMBRE: TAPITEX M&B CIA LTDA
CUENTA CORRIENTE #0049000405
RUC: 0190383229001
CORREO: cartera@tapitex.com

CUENTA BANCO GUAYAQUIL

NOMBRE: IMPORTADORA BALCAZAR GRANJA
CUENTA CORRIENTE #49001622
RUC: 0190431797001
CORREO: cartera@tapitex.com

CUENTA BANCO AUSTRO

NOMBRE: TAPITEX M&B CIA LTDA
CUENTA CORRIENTE #0200190106
RUC: 0190383229001
CORREO: cartera@tapitex.com

RETENCIONES:
retenciones@tapitex.com



INDICE

- 022 TAPIX
- 001 ARMADA
- 002 NELSON
- 002 FERRO
- 022 HOMEY
- 058 RONGPENG
- 030 SCHULZ
- 052 JITool
- 044 HERCULES / WEG
- 053 NORTON
- 022 IMPORTADOS
- 017 DEWALT
- 003 CONDOR
- 019 EVERY
- 031 STANLEY
- 056 FANDELI
- 015 NACIONAL
- 014 CHAIDE



TAPIX

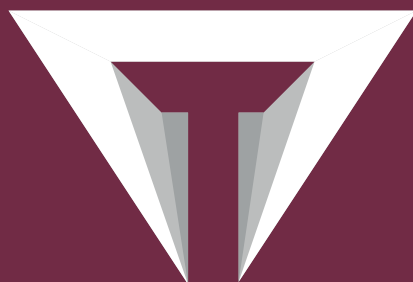



220401

CÉSPED DE HOGAR

TIPO	LIVIANO
ESPESOR	9MM
COLOR	
MARCA	TAPIX
MEDIDA	2X25 MTRS



220408

CÉSPED DE HOGAR

TIPO	LIVIANO
ESPESOR	9 MM
COLOR	
MARCA	TAPIX
MEDIDA	1X25 MTRS



220410

CÉSPED DE HOGAR

TIPO	SEMI PESADO
ESPESOR	15 MM
COLOR	
MARCA	TAPIX
MEDIDA	2X25 MTRS



220402

CÉSPED DE DEPORTIVO

TIPO	MEDIO / TRÁFICO
ESPEJOR	30 MM
COLOR	
MARCA	TAPIX
MEDIDA	2X25 MTRS



220403

CÉSPED DE DEPORTIVO

TIPO	MEDIO / TRÁFICO
ESPEJOR	25 MM
COLOR	
MARCA	TAPIX
MEDIDA	2X25 MTRS



220405

CÉSPED DE DEPORTIVO

TIPO	ALTO TRÁFICO
ESPEJOR	50 MM
COLOR	VERDE CLARO/OSCURO
MARCA	TAPIX
MEDIDA	4X25 MTRS



220409

CÉSPED DE HOGAR

TIPO	SEMI PESADO
ESPEJOR	15 MM
COLOR	
MARCA	TAPIX
MEDIDA	1X25 MTRS



223450

CINTA UNION PARA CESPED

MARCA	TAPIX
MEDIDA	30 CM X R300MT



223409

CINTA ADHESIVA UNION PARA CESPED

MARCA	TAPIX
MEDIDA	12 CM X R10MT



229702

CÉSPED JARDÍN VERTICAL

TIPO	Hoja Fina Verde Osc.
REFERENCIA	Dyg-A/21
MEDIDA	40x60 cmts
CARTON	65



229703

CÉSPED JARDÍN VERTICAL

TIPO	
REFERENCIA	Whdy-2
MEDIDA	40x60 cmts
CARTON	80



229704

CÉSPED JARDÍN VERTICAL

TIPO	
REFERENCIA	Whdy-11
MEDIDA	40x60 cmts
CARTON	55



229705

CÉSPED JARDÍN VERTICAL

TIPO	
REFERENCIA	Whdy-18
MEDIDA	40x60 cmts
CARTON	48



229707

CÉSPED JARDÍN VERTICAL

TIPO	
REFERENCIA	Whdy-19
MEDIDA	40x60 cmts
CARTON	70



229708

CÉSPED JARDÍN VERTICAL

TIPO	
REFERENCIA	Whdy-32
MEDIDA	40x60 cmts
CARTON	48



229709

CÉSPED ENREDADERA PARED

TIPO	
REFERENCIA	Dyg-11/2
MEDIDA	40x60 cmts
CARTON	50



229711

CÉSPED JARDÍN VERTICAL

TIPO	Exterior /Alto Rendim Uv
REFERENCIA	Dyg-A/1
MEDIDA	50x50 cmts
CARTON	55



229712

CÉSPED JARDÍN VERTICAL

TIPO	Exterior /Alto Rendim Uv
REFERENCIA	Dyg-3/1
MEDIDA	50x50 cmts
CARTON	40



229713

CÉSPED JARDÍN VERTICAL

TIPO	Exterior/Alto Rendim Uv
REFERENCIA	Dyg-4/1
MEDIDA	50x50 cmts
CARTON	55



229714

CÉSPED JARDÍN VERTICAL

TIPO	
REFERENCIA	Whdy-13
MEDIDA	40x60 cmts
CARTON	55



229700

CÉSPED JARDÍN VERTICAL

REF.:	
TIPO	HOJAS
TAMAÑO	40X60CM
CARTÓN	CRT30-10

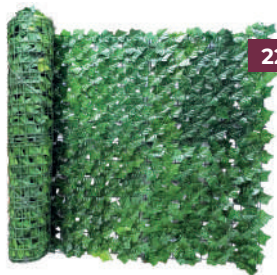

229723

CÉSPED ENREDADERA PARED

TIPO	
REFERENCIA	Wyivy306014
MEDIDA	R1x3mtr
CARTON	25

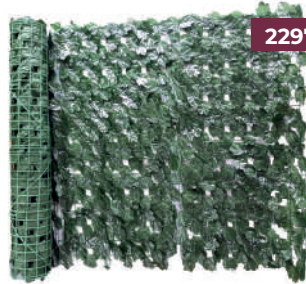

229724

CÉSPED ENREDADERA PARED

TIPO	
REFERENCIA	Wyivy306015
MEDIDA	R1x3mtr
CARTON	25

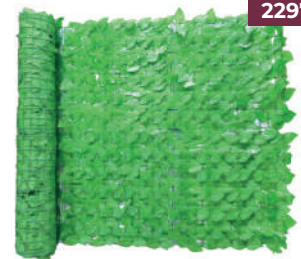

229722

CÉSPED ENREDADERA PARED

TIPO	
REFERENCIA	Wyivy30608
MEDIDA	R1x3mtr
CARTON	25

PEGAMENTO PARA ESPONJA AL SOPLETE

Es un pegamento respetuoso con el medio ambiente con un buen rendimiento operativo, que pega de forma inmediata, por lo que podemos continuar con nuestro trabajo una vez adherido. Es muy sencillo de aplicar, es adecuado para la unión de grandes áreas entre materiales como: esponja con madera, textil, metal y papel.



Para fabricación de
muebles de sala

CÓDIGO	NOMBRE	PRESENTACIÓN	CAFETERA	PESO	MASTER	MARCA
071611	PEGAMENTO LÍQUIDO	1/2 CANECA	1.7MM	6.8kg SOPLETE		TAPIX
071612	PEGAMENTO LÍQUIDO	CANECA	1.7MM	14 KG		TAPIX
071411	PEGAMENTO LÍQUIDO	GALÓN	1.7MM		6 UNIDADES	TAPIX
071412	PEGAMENTO LÍQUIDO	1/4	1.7MM		20 UNIDADES	TAPIX



220142

PEGA TUBO

TIPO	PVC
REF.:	Pa125
CANT.:	125 GR
CARTÓN	24
MARCA	TAPIX

CÓDIGO	NOMBRE	REF.	GRAMAJE	COLOR	CARTÓN	MARCA
223501	HILO NYLON	6010-0446	100 GR 210D/3	BLANCO	CTR 6	TAPIX
223502	HILO NYLON	6010-0448	100 GR 210D/3	NEGRO	CTR 6	TAPIX
223503	HILO NYLON	6010-0447	100 GR 210D/3	GRIS OSCURO	CTR 24	TAPIX
223504	HILO NYLON	6010-447	100 GR 210D/3	KAKI	CTR 24	TAPIX
223505	HILO NYLON	6010-447	100 GR 210D/3	CAFÉ	CTR 24	TAPIX
223506	HILO NYLON	6010-447	100 GR 210D/3	ROJO	CTR 24	TAPIX
223510	HILO NYLON	6033-1126	400 GR 210D/3	BLANCO	CTR 6	TAPIX
223511	HILO NYLON	6033-1129	400 GR 210D/3	NEGRO	CTR 6	TAPIX
223512	HILO NYLON	6033-1128	400 GR 210D/3	GRIS	CTR 18	TAPIX
223513	HILO NYLON	6033-1128	400 GR 210D/3	KAKI	CTR 18	TAPIX
223514	HILO NYLON	6033-1128	400 GR 210D/3	CAFÉ	CTR 18	TAPIX
223520	HILO NYLON	6033-1126	400 GR 210D/6	BLANCO	CTR 6	TAPIX
223521	HILO NYLON	6033-1129	400 GR 210D/6	NEGRO	CTR 6	TAPIX
223522	HILO NYLON	6033-1128	400 GR 210D/6	CAFÉ		TAPIX





REVESTIMIENTOS DE INTERIOR Y EXTERIOR



CALIDAD
INTERNACIONAL



ARMADA
ALPHATOOLS



**USOS:
EN GRANITO,
MARMOL
Y QUARZO**

6.800RPM-Amoladora 9"



**USO
PULIDO**

CÓDIGO	NOMBRE	GRANO	MEDIDA	CARTÓN
010924	Disco Copa	120	125X50X15.88	Crt 20
010909	Disco Copa	100	125X50X15.88	Crt 20
010919	Disco Copa	80	125X50X15.88	Crt 20
010925	Disco Copa	60	125X50X15.88	Crt 20

CÓDIGO	NOMBRE	"	TIPO	CARTÓN
019050	Mota	7	Económica	120-12
019051	Mota	7	Reforzada	120-12

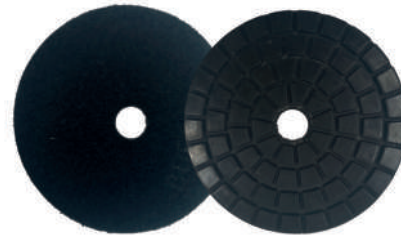
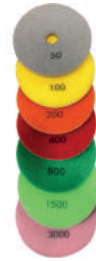
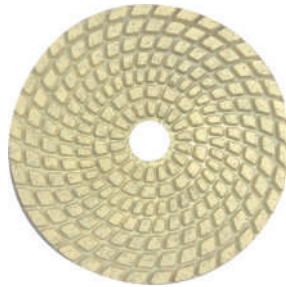

Mar-Gra-Piedra

CÓDIGO	NOMBRE	GRS.	COLOR	MARCA	CARTÓN
010941	Disco Pulir	50	Gris	Armada	Crt 10
010942	Disco Pulir	100	Amarillo	Armada	Crt 10
010943	Disco Pulir	200	Naranja	Armada	Crt 10
010944	Disco Pulir	400	Rojo	Armada	Crt 10
010945	Disco Pulir	800	Verde	Armada	Crt 10
010946	Disco Pulir	1500	Verde	Armada	Crt 10
010947	Disco Pulir	3000	Rosado	Armada	Crt 10
010949	Disco Pulir	10000	Negro	Armada	Crt 10

CÓDIGO	NOMBRE	GRANO	PULG.	MARCA	CARTÓN	CAJA
010905	Disco Flap	60 gr	4.5	Armada	200	Unid
010906	Disco Flap	80 gr	4.5	Armada	200	Unid
010907	Disco Flap	100 gr	4.5	Armada	200	Unid
010908	Disco Flap	120 gr	4.5	Armada	200	Unid
010914	Disco Flap	40 gr	4.5	Armada	200	Unid
010915	Disco Flap	60 gr	7	Armada	100	Unid
010916	Disco Flap	80 gr	7	Armada	100	Unid
010917	Disco Flap	100 gr	7	Armada	100	Unid
010918	Disco Flap	120 gr	7	Armada	100	Unid
010920	Disco Flap	40 gr	7	Armada	100	Unid





MADERA



010959

DISCO CORTE MÚLTIPLE

MEDIDA	115 X 22.23 MM
RPM	13800
USO	MADERA FIBRA, VIDRIO PLÁSTICO Y YESO
MASTER	Crt 50
MARCA	Armada

CÓDIGO	NOMBRE	PULG.	MM	MARCA	CARTÓN	CAJA
010923	Disco Segm	4.5	115 mm	Armada	Crt 200	10 Unid
010922	Disco Segm	7	180 mm	Armada	Crt 50	10 Unid
010921	Disco Segm	9	230 mm	Armada	Crt 25	10 Unid



CÓDIGO	NOMBRE	PULG.	PARA
010930	DISCO CORTE	7-1/4X40T	MADERA
010932	DISCO CORTE	7-1/4X60T	MADERA
019031	DISCO CORTE	10X40T	MADERA
010933	DISCO CORTE	10X60T	MADERA
010934	DISCO CORTE	10X80T	MADERA
010935	DISCO CORTE	12X40T	MADERA
010936	DISCO CORTE	12X60T	MADERA
010937	DISCO CORTE	12X100T	MADERA

CÓDIGO	NOMBRE	PULG.
010950	DISCO CORTE ALUMINIO	10X80T
010951	DISCO CORTE ALUMINIO	10X100T
010955	DISCO CORTE ALUMINIO	12X80T
010956	DISCO CORTE ALUMINIO	12X100T
010960	DISCO CORTE ALUMINIO	7-1/4X80T



010938



DISCO GOMA PULIDORA

COD.	REF.	PULG.	CARTÓN
019052	CRO154	7 pulg.	CRT 50
019053		4.5 pulg.	



011008

COPA CEPILLO METALICO

REF	CRT
MARCA	ARMADA
COLOR	ROJO
MEDIDA	4"

DISCO CORTE MADERA

MEDIDA	12X80T
MARCA	ARMADA
CARTÓN	10

011007

**COPA CEPILLO
METALICO TRENZADO**

REF	CRT
MARCA	ARMADA
COLOR	ROJO
MEDIDA	4"

**MEDIDA
pulg / mm**

CÓDIGO	NOMBRE	PULG	MM	TACO	TIPO	REF.	MASTER	CAJA
010808	BROCA	1/2	12.7	F12	CONCRETO	DIN8039	250/500	5
010803	BROCA	1/4	6.35	F6	CONCRETO	DIN8039	1000	10
010801	BROCA	3/8	9.52	F10	CONCRETO	DIN8039	500	10
010804	BROCA	3/16	4.76	F5	CONCRETO	DIN8039	1000	10
010800	BROCA	5/16	7.93	F8	CONCRETO	DIN8039	500	10



CÓDIGO	NOMBRE	MEDIDA pulg / mm		COLOR	REF.	MARCA	MASTER	CAJA
010606	BROCA	1/2	12.7	ACERO	DIN338	ARMADA	100/200	5
010607	BROCA	1/4	6.35	ACERO		ARMADA	100	10
010601	BROCA	1/8	3.175	ACERO		ARMADA	4000/100	10
010608	BROCA	3/8	9.52	ACERO	DIN338	ARMADA	500	10
010602	BROCA	3/16	4.76	ACERO		ARMADA	100	10
010603	BROCA	3/32	2.38	ACERO		ARMADA	100	10
010604	BROCA	3/64	1.19	ACERO		ARMADA	100	10
010609	BROCA	5/16	7.93	ACERO		ARMADA	100	10
010605	BROCA	5/32	3.96	ACERO	DIN338	ARMADA	100	10
010610	BROCA	5/64	1.98	ACERO		ARMADA	100	10
010611	BROCA	7/16	11.11	ACERO	DIN338	ARMADA	50/250	5
010612	BROCA	7/32	5.55	ACERO		ARMADA	100	10
010614	BROCA	7/64	2.77	ACERO		ARMADA	100	10
010613	BROCA	9/32	7.14	ACERO		ARMADA	100	10
010615	BROCA	9/64	3.57	ACERO		ARMADA	100	10
010616	BROCA	11/64	4.36	ACERO		ARMADA	100	10

CÓDIGO NOMBRE MEDIDA

510005	TACO F HSL	F-5 FUNDA 3000-500
510006	TACO F HSL	F-6 FUNDA 2000-500
510008	TACO F HSL	F-8 FUNDA 1000-200
510010	TACO F HSL	F-10 FUNDA 500-100
510106	TACO F HSL	F-6 FUNDA 2000-500
510108	TACO F HSL	F-8 FUNDA 1000-200
510110	TACO F HSL	F-10 FUNDA 500-100





Para bisagra
CODO, SEMI CODO Y RECTA

CÓDIGO	NOMBRE	MEDIDA	MARCA	TIPO	CARTÓN
010618	BROCA FORSTNER	35MM	ARMADA	BISAGRA	CRT 160
010620	BROCA FORSTNER	26MM	ARMADA	BISAGRA	



JUEGO BROCA CONICA METAL	
REF	CRT
MARCA	ARMADA
COLOR	DORADO
PIEZAS	2 PIEZAS



010632

JUEGO DE BROCA CÓNICA	
CANTIDAD	5 PCS
FORMA	-
COLOR	DORADO
MASTER	CRT 50
MARCA	ARMADA



010815

BROCA VIDRIO/ALUMIUNIO	
PUNTA	-
MEDIDA	1/4
MASTER	CRT 1000-50
MARCA	ARMADA



010811

BROCA CONCRETO	
PRESEN.	GRANEL
MEDIDA	1/4
TACO	(F6)
MASTER	CRT 1000-100
MARCA	ARMADA

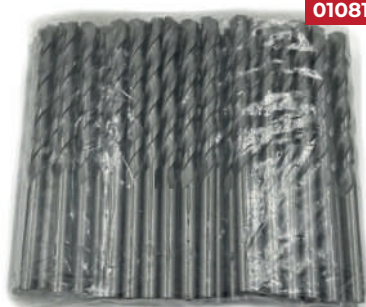

010810

BROCA CONCRETO	
PRESEN.	GRANEL
MEDIDA	5/16
TACO	(F8)
MASTER	CRT 500-100
MARCA	ARMADA



010001

PUNTA SIMPLE	
MEDIDA	2 PG - PH2
FORMA	ESTRELLA
COLOR	(GRIS
MASTER	CRT 5000
CAJA	
MARCA	ARMADA



010003

PUNTA SIMPLE	
MEDIDA	1 PG - PH3
FORMA	ESTRELLA
COLOR	(GRIS
MASTER	CRT 5000
CAJA	
MARCA	ARMADA



010004

PUNTA DOBLE

MEDIDA	2 PG - PH2
FORMA	ESTRELLA
COLOR	GRIS
MASTER	CRT 5000
CAJA	-
MARCA	ARMADA



BROCA CONCRETO

CODIGO	PUNTA	MEDIDA	MASTER
010812	CRUX	5/16	500-500
010813	CRUZ	1/4	1000-50



010809

ADAPTADOR MAGNÉTICO

MEDIDA	5/16
MASTER	CRT 200-5
USO	P/TALADRO
MARCA	ARMADA



010617

BROCA

MEDIDA	22mm
TIPO	PALETA
MASTER	CRT 250
CAJA	1
MARCA	ARMADA



010805

KIT SIERRA COPA Y BROCA

PALETAS	22mm
SACABOCADOS	54mm
TIPO	P/MADERA
MASTER	CRT 100
CAJA	1
MARCA	ARMADA



010814

AVELLANADOR

MEDIDA	8-9
MASTER	CRT 200
MARCA	ARMADA



010806

JUEGO BROCA EXTRACTORA TORNILLOS

REF	CRT
MARCA	ARMADA
COLOR	PLATEADO
PIEZAS	5 PIEZAS
MEDIDAS	1/8-3/16-15/64-5/16-3/8



010619

CLAVILLO

REF	ST-38
MEDIDA	38MM11/2
MASTER	CRT10-1000
MARCA	ARMADA

PARA CLAVADORA
ST38-GD201



011501

BUMPER GRAPADORA N851



011601

PISTON GRAPADORA N851



011506

BUMPER CLAVADORA F50/9040



011602

PISTON GRAPADORA 8016



011502

BUMPER GRAPADORA 8016



011603

PISTON GRAPADORA 8416



010822

ACOPLE HEMBRA

MEDIDA	1/4
REF.	FYB8-2SF
COLOR	NIQUELADO
CAJA	100-20
FUNDA	X5
MARCA	ARMADA



010824

ACOPLE 360

MEDIDA	1/4
REF.	FLP-11
COLOR	NIQUELADO
CAJA	100-20
FUNDA	1
MARCA	ARMADA



010807

ACOPLES KIT 1/4 5PZ

MEDIDA	1/4
PIEZAS	5 PZ
COLOR	DORADO
MASTER	100-25
CAJA	-
MARCA	ARMADA



010816

ACOPLES KIT

MEDIDA	1/4
PIEZAS	2 PZ
COLOR	DORADO
MASTER	100-25
CAJA	-
MARCA	ARMADA



**MIG
SÓLIDA**

CÓDIGO	NOMBRE	ESPESOR	MARCA	PESO/CAJA	PALET
011103	SUELDA MIG	0.8MM	ARMADA	15 KLS	72 CAJA
011104	SUELDA MIG	0.9MM	ARMADA	15 KLS	72 CAJA
011105	SUELDA MIG	1.2MM	ARMADA	15 KLS	72 CAJA



**MIG
SÓLIDA**



CÓDIGO	NOMBRE	ESPESOR	MARCA	PESO/CAJA	REF
011111	SUELDA MIG	0.9MM	ARMADA	5 KLS	ER70S-6



**MIG
TUBULAR**

NOTA

La suelda tubular es un alambre relleno con un fundente formado por agentes desoxidantes y polvo metálico. Se usa principalmente como alambre consumible en la soldadura MAG.

Este alambre se conforma en frío hastadándole una forma de U a partir de una fina lámina y a continuación se rellena confundente o polvo metálico. Finalmente, se extrusiona hasta el diámetro requerido.



**SIN OXÍGENO
TUBULAR**

CÓDIGO	NOMBRE	ESPESOR	PESO/CAJA	REF
011112	SUELDA MIG TUB	1.2MM	15 KL	E71T-1C

CÓDIGO	NOMBRE	ESPESOR	MARCA	PESO/CAJA	REF
011123	SUELDA MIG	0.9MM	ARMADA	1 KL	E71T-GS

011102

**SUELDA 6013**

ESPESOR	1/8
TIPO	ELECTRODO
PESO	5KL
PALET	50
MARCA	BRIDGE

011107

**SUELDA 6011**

ESPESOR	1/8
TIPO	ELECTRODO
PESO	5KL
PALET	50
MARCA	BRIDGE

011121

**SUELDA MIC SOLIDA INDUS**

ESPESOR	0,9MM
TIPO	SOLIDA
PESO	5KL
PALET	200
MARCA	BRIDGE



CÓD.	NOMBRE	ESPESOR	MARCA	PESO/CAJA	PALET
011119	SUELDA 7018	1/8	BRIDGE	5 KL	50
011120	SUELDA 7018	5/32	BRIDGE	5 KL	50

**INDUSTRIAL SOLIDA**

CÓDIGO	NOMBRE	ESPESOR	MARCA	PESO/CAJA	PALET
011116	SUELDA MIG	0,8MM	BRIDGE	15 KL	72
011117	SUELDA MIG	0,8MM	BRIDGE	5 KL	200
011118	SUELDA MIG	0,9MM	BRIDGE	15 KL	72

011122

**SUELDA MIC TUBULAR INDUS**

ESPESOR	1,2MM
TIPO	ELECTRODOTUBULAR5KL
PESO	50
PALET	200
MARCA	BRIDGE

011106

**SUELDA MIC TUBULAR INDUS**

ESPESOR	1,2 MM
TIPO	TUBULAR
PESO	15KL
PALET	72
MARCA	BRIDGE



013041

**PANEL REDONDO PERDIDO**

WATS	3W
COLOR	6500K
REF.	IP001RR
CARTÓN	100
MARCA	GRINLITE

CÓDIGO	NOMBRE	WATS	LUZ	MODELO	REF.	MARCA	CARTÓN
013045	PANEL	12W	6500 °K	REDON PERD	RPAI	GRINLITE	30
013047	PANEL	18W	6500 °K	REDON PERD	RPAI	GRINLITE	20



CÓDIGO	NOMBRE	WATS	LUZ	REF.	BOQUILLA	MARCA	CARTÓN
013019	PANEL CUADRADO	12W	6500 °K	YX-SPA	E27	ARMADA	40
013020	PANEL CUADRADO	18W	6500 °K	YX-SPA	E27	ARMADA	40

**DICROICO**

WATS	7W
COLOR LUZ	3500 °K
BOQUILLA	
REF	YS-SPS-MR16
CARTÓN	100
MARCA	ARMADA



013000

LUZ EXTERIOR

WATS	120 W
COLOR LUZ	6500 °K
REF	OR025
CARTÓN	
MARCA	GRINLITE



CAJA ALUMINIO

CÓDIGO	NOMBRE	PIEZAS	MARCA
010631	JUEGO FRESA	12 PIEZAS	ARMADA



CÓDIGO	NOMBRE	PIEZAS	MARCA
010633	JUEGO FRESA	6 PIEZAS	ARMAD
010635	JUEGO FRESA	12 PIEZAS	ARMADA



0112080

COMPRESOR

CABALLAJE	2HP
VOLTAJE	120-240V
PRESIÓN	8BAR
REVOLUCIÓN	3450RPM
REF.	UH30-76L
CFM	9.6 - 115PSI



0112101

COMPRESOR

CABALLAJE	2HP
VOLTAJE	120-240V
PRESIÓN	8BAR
REVOLUCIÓN	3450RPM
REF.	UV30-102L
CFM	9.6 - 115PSI



011326

COMPRESOR

CABALLAJE	3HP
VOLTAJE	220V - BIF
PRESIÓN	10BAR
REVOLUCIÓN	3550RPM
REF.	UV30-228L
CFM	11.3 - 145PSI



01151150

COMPRESOR

CABALLAJE	5.5HP
VOLTAJE	220V - BIF
PRESIÓN	12BAR
REVOLUCIÓN	1750RPM
REF.	UT55-300L
CFM	19.3 - 175PSI



01151151

COMPRESOR

CABALLAJE	5.5HP
VOLTAJE	220V - BIF
PRESIÓN	12BAR
REVOLUCIÓN	1750RPM
REF.	TV55-300L
CFM	19.3 - 175PSI



011324

COMPRESOR

CABALLAJE	10HP
VOLTAJE	220V - TRIF
PRESIÓN	12BAR
REVOLUCIÓN	1750RPM
REF.	UT100-300L
CFM	35.4 - 175PSI



011325

COMPRESOR

CABALLAJE	15HP
VOLTAJE	220V - TRIF
PRESIÓN	12BAR
REVOLUCIÓN	1750RPM
REF.	UT150-300L
CFM	48.4 - 175PSI



01231110

CABEZAL

MOTOR	3HP
REVOLUCIÓN	1100RPM
REF.	UB30
CFM	11.8-145PSI
PRESIÓN	10BAR



01212080

CABEZAL

MOTOR	3HP
REVOLUCIÓN	1180RPM
REF.	UH30
CFM	13.8-145PSI
PRESIÓN	10BAR



01241150

CABEZAL

MOTOR	5HP
REVOLUCIÓN	750RPM
REF.	UT50A
CFM	19.8-175PSI
PRESIÓN	12BAR



012314

CABEZAL

MOTOR	5.5HP
REVOLUCIÓN	1000RPM
REF.	UB55
CFM	21.3-145PSI
PRESIÓN	10BAR



012310

CABEZAL

MOTOR	5.5HP
REVOLUCIÓN	1000RPM
REF.	FB55 INDUSTRIAL
CFM	21.4-145PSI
PRESIÓN	10BAR



012311

CABEZAL

MOTOR	7.5HP
REVOLUCIÓN	1000RPM
REF.	FB75 INDUSTRIAL
CFM	32-145PSI
PRESIÓN	10BAR



012315

CABEZAL

MOTOR	7.5HP
REVOLUCIÓN	1100RPM
REF.	UB75
CFM	35-145PSI
PRESIÓN	10BAR



012312

CABEZAL

MOTOR	10HP
REVOLUCIÓN	850RPM
REF.	FB100 INDUSTRIAL
CFM	49.4-145PSI
PRESIÓN	10BAR



012317

CABEZAL

MOTOR	10HP
REVOLUCIÓN	730RPM
REF.	FT100 INDUSTRIAL
CFM	39.7-175PSI
PRESIÓN	12BAR



012318

CABEZAL

MOTOR	15HP
REVOLUCIÓN	900RPM
REF.	UT150
CFM	57.6-175PSI
PRESIÓN	12BAR



012313

CABEZAL

MOTOR	15HP
REVOLUCIÓN	800RPM
REF.	FB150 INDUSTRIAL
CFM	76.6-145PSI
PRESIÓN	10BAR



010507

FILTRO

ENTRADA	26MM
P. COMPRE	UV30-102L / UV30-228L UH30-76
P. CABEZAL	UB75 / UB55 / UH30



010508

FILTRO

ENTRADA	8MM
CA. PERNO	10MM
P. COMPRE	1UB30-200L
P. CABEZAL	UB30



010509

FILTRO

ENTRADA	32.5MM
P. COMPRE	UT100-300L / TV55-300L UT55-300L
P. CABEZAL	UT100 / UT50A



010504

FILTRO COMPRESOR

P. CABEZAL	FB75/FB55
REF	FB55/75
TIPO	AIRE
MARCA	ARMADA



010500

FILTRO COMPRESOR

P. CABEZAL	UB75 / UB55
P. COMPRE	UH30-76L / UV30-102L
TIPO	UV30-228L
MARCA	ARMADA



010501

FILTRO COMPRESOR

P. CABEZAL	FB100 / FB150 / UT50A UT100 / UT150
P. COMPRE	FB100 / FB150 / UT50A UT100 / UT150E



010502

FILTRO COMPRESOR

P. CABEZAL	UB30
P-COMPRE	UB30-200L
TIPO	AIRE
MARCA	ARMADA

010503

**FILTRO COMPRESOR**

PARA	5.5HP
TIPO	ACEITE
MARCA	ARMADA

010303

**MOTOR**

CABALLAJE	2HP
VOLTAJE	MONOFASICA 110-220V
REF.	UH3076
RPM	3450 RPM
MARCA	ARMADA

010304

**MOTOR**

CABALLAJE	3HP
VOLTAJE	BIFASICO-220V
REF.	UH3076
RPM	3550 RPM
MARCA	ARMADA

015024

**PISTOLA P/SILICON 1200**

CARTÓN	50
COLOR	ROJO
MARCA	ARMADA

015019



Venta por unidad

FILTRO MASCARA QUIMICO C-2006A #7

REF	CRT50
MARCA	ARMADA
COLOR	GRIS
TIPO FILTRO	GAS-VAPORES ACIDOS
COMPOSICIÓN	CARBONO ACTIVADO
USO	INDUSTRIAL

015023

**OREJERAS E-3101**

REF	CRT50
MARCA	ARMADA
COLOR	AMARILLO
MAX. RUIDO	150 DBA
MIN. RUIDO	30 DBA
TALLA	GENERAL
MATERIAL	PLASTICO ABS
RESISTENTE HUMEDAD	NO

015020



USO INDUSTRIAL

MASCARA QUIMICO ST-M60X-3B

TIPO	SIN FILTRO
REF	ST-M60X-3B
COLOR	GRIS
MARCA	ARMADA



015010

USO INDUSTRIAL
Adaptable a 3M

KIT FILTRO DE VAPORES QUIMICOS

TIPO	3 PARES
REF	PC-206
COLOR	GRIS
MARCA	ARMADA



015011

USO INDUSTRIAL
Adaptable a 3M

FILTRO DE VAPORES QUIMICOS

TIPO	1 PAR
REF	PC-206
COLOR	GRIS
MARCA	ARMADA



NELSON

HERRAJES / MAQUINARIA

Cerradura / Pomo

 Dormitorio

 Baño

Código	Color	Tipo	Código	Color	Tipo
591202	Ab	Dormitorio	591211	Ab	Baño
591201	Sn	Dormitorio	591310	Sn	Baño
591203	Negro	Dormitorio	591210	Negro	Baño

Cerradura / Pomo con tornillos expuestos (65mm)

 Dormitorio

 Baño

Código	Color	Tipo	Código	Color	Tipo
591302	Ab	Baño	591215	Negro	Dormitorio
591212	Negro	Baño	591154	Sn	Dormitorio
591214	Sn	Baño	591155	Ab	Dormitorio

Cerradura / Manija

 Dormitorio

 Baño

Código	Color	Tipo	Código	Color	Tipo
591114	Sn	Dormitorio	591110	Sn	Baño
591115	Ab	Dormitorio	591111	Ab	Baño
591120	Negro	Dormitorio	591121	Negro	Baño

Cerradura / Manija con tornillos expuestos (65mm)



 Dormitorio

 Baño



Código	Color	Tipo
591150	Ab	Baño
591151	Negro	Baño
591152	Sn	Baño

Código	Color	Tipo
591153	Negro	Dormitorio
591156	Sn	Dormitorio

Cerradura / Manija recta



 Llave - llave

 Llave - Seguro



Código	Color	Tipo
591109	Sn	Dormitorio
591118	Negro	Dormitorio
591119	Ab	Dormitorio

Código	Color	Tipo
591123	Negro	Baño
591108	Sn	Baño
591122	Ab	Baño

Cerradura / Pico de loro



 Llave - Seguro



Código	Color	Tipo
591140	Sn	Puerta deslizante
591141	Negro	Puerta deslizante

Cerradura / Cerrojo cuadrada



 Llave - llave

 Llave - Seguro

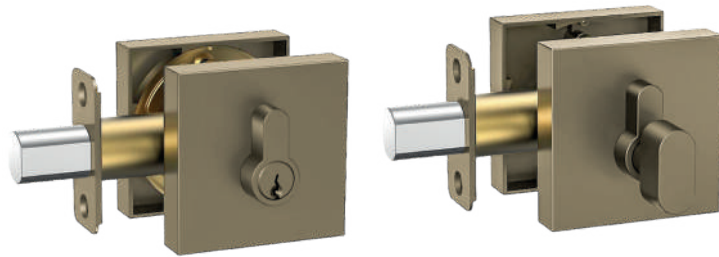

Código	Color	Tipo	Código	Color	Tipo
591408	Ab	Llave-seguro	591411	Ab	Llave-seguro
591409	Negro	Llave-llave	591406	Negro	Llave-seguro
591410	Sn	Llave-llave	591407	Sn	Llave-seguro

Cerradura / Cerrojo



 Llave - llave

 Llave - Seguro



Código	Color	Tipo	Código	Color	Tipo
591401	Sn	Llave-llave	591403	Ab	Llave-seguro
591405	Negro	Llave-llave	591400	Sn	Llave-seguro
591402	Ab	Llave-llave	591404	Negro	Llave-seguro

Cerradura / Entrada cuadrada



 Llave - llave

 Llave - Seguro



Código	Color	Tipo	Código	Color	Tipo
591112	Sn	Llave-seguro	591116	Sn	Llave-llave
591113	Ab	Llave-seguro	591117	Ab	Llave-llave
591125	Negro	Llave-seguro	591124	Negro	Llave-llave

Cerradura / Entrada redonda

 Llave - llave

 Llave - Seguro



Código	Color	Tipo
591126	Negro	Llave-llave
591128	Sn	Llave-llave

Código	Color	Tipo
591127	Negro	Llave-seguro
591129	Sn	Llave-seguro

Cerradura / Manuel de portón

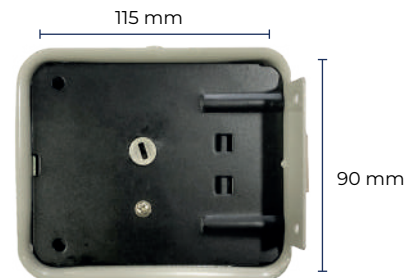

64 mm
Medida del pestillo
al ojo de la cerradura



Código	Color	Dirección
591133	Verde	Izquierda

Cerradura / Portón eléctrica pulsante

 Llave - llave

Código	Color	Dirección
591130	Sn	Derecha
591131	Sn	Izquierda

Cerradura / Portón eléctrica con botón

AB



Llave - Botón



Código	Color	Tipo
591136	Sn	Izquierdo
591137	Sn	Derecho

Cerradura / Portón con engranaje

VERDE



Llave - llave



Código	Dirección	Tipo
591135	Izquierdo	Llave-llave
591132	Derecho	Llave-llave

Cerradura / Casera

AB



Llave - Seguro



Código	Color	Tipo
021419	Bronce	Llave-seguro

Cerradura / Manual para portón

 VERDE

Llave - Botón



Código	Tipo	Tipo
591142	Izquierda	22F-RIM
591143	Derecha	22F-RIM

Cerradura / Eléctrica con teclado

 NEGRO

 SN

Llave - Seguro

Código	Color	Tipo
690004	Negro	Llave-código



Cerradura / Digital

 NEGRO

 SN

Métodos de desbloqueo	Tarjeta RFID, contraseña, App (TT lock), llave
Usuarios	Hasta 200
Voltajes	4 AA/1.5V batteries (Normal 9 meses cada cambio)



Manual de instalación

Código	Color	Tipo
690000	Negro	Derecha
690002	Negro	Izquierda





ACCESORIOS

DE COCINA



CUBERTERO | 800C

590024



Módulo 800mm

Alto(mm)	Anch(mm)		Prof(mm)	
60	Max	Min	Max	Min
	730	670	480	430

CUBERTERO | 600C

590033



Módulo 600mm

Alto(mm)	Anch(mm)		Prof(mm)	
40	Max	Min	Max	Min
	550	475	480	370

CUBERTERO | 400A

590030

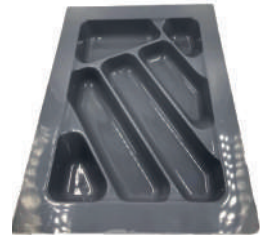

Módulo 400mm

Alto(mm)	Anch(mm)		Prof(mm)	
50	Max	Min	Max	Min
	340	275	480	405

CUBERTERO | 400D

590031



Módulo 400mm

Alto(mm)	Anch(mm)	Prof(mm)
40	350	450

CUBERTERO | E0650E

590035



Módulo 600mm

Alto(mm)	Anch(mm)	Prof(mm)
64	515	478

CUBERTERO | E0650U

590036



Módulo 900mm

Alto(mm)	Anch(mm)	Prof(mm)
64	815	478



SOPORTE PALETAS | TH-103

590041



Peso 8.7kg

Alto(mm)	Anch(mm)	Prof(mm)
400	250	150

ORG. ESCOBAS | HX-267

590046



Modelo 5 ganchos - Acero

Alto(mm)	Anch(mm)	Prof(mm)
30	490	-

ORG. ESCOBAS | HX-267

590049



Modelo 3 ganchos - Acero

Alto(mm)	Anch(mm)	Prof(mm)
30	370	-

ORG. ESCOBAS | DX01SN

590047



Modelo 1 gancho - Acero

Alto(mm)	Anch(mm)	Prof(mm)
70	85	-

PORTA PAPEL | TH302

593301



Peso 7.2kg

Alto(mm)	Anch(mm)	Prof(mm)
325	160	330

REPISA COPAS | TH110A

593304



Peso 4kg

Alto(mm)	Anch(mm)	Prof(mm)
36	115	34



SALVAMANTELES | TH216A

598002

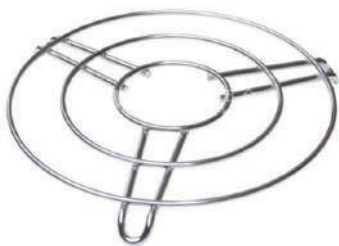

Uso para ollas

Alto(mm)	Anch(mm)	Prof(mm)
-	200	200

MINI BAR | TH-601

593303



Peso 7.3kg

Alto(mm)	Anch(mm)	Prof(mm)
305	900	300

PLANCHADOR | YT-05/A310

598005



Color gris

Alto(mm)	Anch(mm)	Prof(mm)
300	430	140

ESPEJO EXTRAIBLE | A821

598001



Marca Nelson

Alto(mm)	Anch(mm)	Prof(mm)
120	370	15

ZAPATERA | STOO60

598003



Material Hierro

Alto(mm)	Anch(mm)	Prof(mm)
-	-	-

ZAPATERA | STOO30

598004



Material Plástico

Alto(mm)	Anch(mm)	Prof(mm)
-	-	-



PANTALONERA EXTRAIBLE | CIERRE LENTO



598000

Doble con esponja

Alto(mm)	Anch(mm)	Prof(mm)
120	660	450

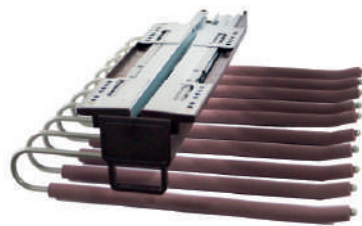

598006

Simple con esponja

Alto(mm)	Anch(mm)	Prof(mm)
120	350	450

ORG. GRIFO | ZX-LT01

590064



Acero - Negro

Alto(mm)	Anch(mm)	Prof(mm)
65	105	235

PANTALONERA EXTRAIBLE | CIERRE LENTO



598007

Simple Niquelado

Alto(mm)	Anch(mm)	Prof(mm)
100	340	470



598008

Doble Niquelado

Alto(mm)	Anch(mm)	Prof(mm)
100	670	470



ORGANIZADOR | YY-B104-A

590051



Negro - 3 niveles

Alto(mm)	Anch(mm)	Prof(mm)
720	700	400

ORGANIZADOR | YY-B104-B

590052



Negro - 3 niveles

Alto(mm)	Anch(mm)	Prof(mm)
745	570	250

ORGANIZADOR | YY-B104-C

590053



Negro - 3 niveles

Alto(mm)	Anch(mm)	Prof(mm)
635	600	280

GANCHO PARED | RU6

590058



Acero 304 - 6 ganchos

Alto(mm)	Anch(mm)	Prof(mm)
60	130	-

SOPORTE CAMISAS | Y03-3

590055



Medida 300 mm - Hierro cromado

Alto(mm)	Anch(mm)	Prof(mm)
75	450	60

PORTA PAPEL | 9863

590060



Acero 304

Alto(mm)	Anch(mm)	Prof(mm)
125	125	125



FRUTERO | ZX-V06

590070



Hierro cromado - 4 niveles

Alto(mm)	Anch(mm)	Prof(mm)
980	420	350

ORG. DE HOGAR | ZX-FT04

590071



Hierro cromado - 3 niveles

Alto(mm)	Anch(mm)	Prof(mm)
875	450	300

ORG. DE HOGAR | ZX-FT16

590072

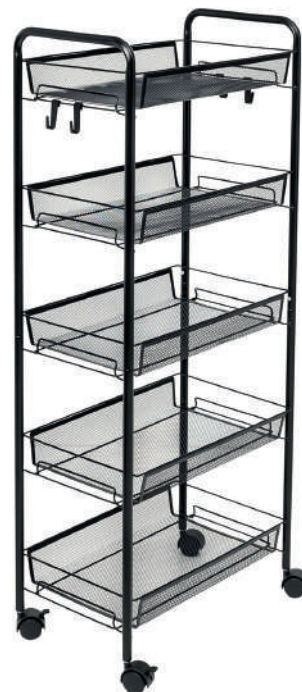

Hierro cromado - 5 niveles

Alto(mm)	Anch(mm)	Prof(mm)
1050	485	265



ORG. DE HOGAR | ZX-FT09

590073



Hierro cromado - 3 niveles

Alto(mm)	Anch(mm)	Prof(mm)
775	415	280

ORG. DE HOGAR | ZX-FT18

590074



Hierro cromado - 3 niveles

Alto(mm)	Anch(mm)	Prof(mm)
865	425	345

REPISA | ZX-P02

590075



Hierro cromado - 3 niveles

Alto(mm)	Anch(mm)	Prof(mm)
700	470	340



REPISA | ZX-P02

590076



Hierro cromado - 5 niveles

Alto(mm)	Anch(mm)	Prof(mm)
1340	510	355

ORGANIZADOR | ZX-FT10

590077



Hierro cromado - 5 niveles

Alto(mm)	Anch(mm)	Prof(mm)
1610	710	340

ORGANIZADOR | ZX-FT14

590078



Hierro cromado - 5 niveles

Alto(mm)	Anch(mm)	Prof(mm)
1100	400	305



ORG. ESPECIAS | ZX-SD05

593309



Hierro cromado - 3 niveles

Alto(mm)	Anch(mm)	Prof(mm)
575	255	255



CANASTILLA MOVIL | ZX-SD11

593310



Acero inoxidable - 3 niveles

Alto(mm)	Anch(mm)	Prof(mm)
605	435	225



ORG. ESPECIAS | ZX-SD11

593307



Acero inoxidable - 2 niveles

Alto(mm)	Anch(mm)	Prof(mm)
400	435	230



ORG. ESPECIAS | ZX-514

593308



Acero inoxidable - 2 niveles

Alto(mm)	Anch(mm)	Prof(mm)
430	275	370



PORTASOMBRILLA | ZX-SJ01

590080



Hierro cromado

Alto(mm)	Anch(mm)	Prof(mm)
405	338	85



ROPERO | ZX-YJ01

590081



Acero inoxidable - Con ruedas

Alto(mm)	Anch(mm)	Prof(mm)
1750	615	490



PLATERO MOVIL | ZX-YJ01

592216



Acero inoxidable - 2 niveles

Alto(mm)	Anch(mm)	Prof(mm)
385	360	265



PLATERO MOVIL | ZX-O08

593305



Acero inoxidable - 2 niveles

Alto(mm)	Anch(mm)	Prof(mm)
430	275	370



PLATERO MOVIL | ZX-WJ01

592200



Acero inoxidable - 2 niveles

Alto(mm)	Anch(mm)	Prof(mm)
380	310	310



PLATERO MOVIL | ZX-WJ04

592205



Hierro cromado - Blanco

Alto(mm)	Anch(mm)	Prof(mm)
162	350	150

PLATERO MOVIL | ZX-WJ05

592204



Hierro cromado - Blanco

Alto(mm)	Anch(mm)	Prof(mm)
195	165	350

VAJILLERO MOVIL | ZX-WJ02

595209



Hierro cromado - Blanco

Alto(mm)	Anch(mm)	Prof(mm)
250	480	240

ESCURRE PLATOS | MOVIL

592100



Alto(mm)	Anch(mm)	Prof(mm)
117	390	255

PLATERO | HIERRO CROMADO

Fijo



592211

Módulo 600mm - 3 piezas - TH-600C

Alto(mm)	Anch(mm)	Prof(mm)
280	565	65

592210

Módulo 800mm - 3 piezas - TH-800C

Alto(mm)	Anch(mm)	Prof(mm)
280	765	65

592214

Módulo 900mm - 3 piezas - TH-900C

Alto(mm)	Anch(mm)	Prof(mm)
280	865	65



BASURERO SIMPLE | S072211.32

590720



Módulo 400mm -Sin tapa - 30L

Alto(mm)	Anch(mm)	Prof(mm)
490	280	470

BASURERO DOBLE | S08222.28

590721



Módulo 450mm -Sin tapa - 2x28L

Alto(mm)	Anch(mm)	Prof(mm)
440	435	540

BASURERO DOBLE | S07212.35

590722



Módulo 450mm -Sin tapa - 2x35L

Alto(mm)	Anch(mm)	Prof(mm)
550	440	540

BASURERO DOBLE | S072212.50

590723



Módulo 450mm -Sin tapa - 2x50L

Alto(mm)	Anch(mm)	Prof(mm)
625	435	500

BASURERO SIMPLE | S08122.30

590724



Módulo 350mm -Sin tapa - 30L

Alto(mm)	Anch(mm)	Prof(mm)
510	260	465

BASURERO SIMPLE | TLS-006A

590727



Módulo 400mm -35L - Con tapa

Alto(mm)	Anch(mm)	Prof(mm)
630	285	450

BASURERO SIMPLE | TLS-006A

590705



Módulo 400mm - Peso 5.7kg - Con tapa - 20L

Alto(mm)	Anch(mm)	Prof(mm)
410	275	400

BASURERO DOBLE | S071312.18

590709



Módulo 400mm - Peso 5.7kg - Con tapa - 18L

Alto(mm)	Anch(mm)	Prof(mm)
460	345	505

BASURERO DOBLE | TLS-006B

590728



Módulo 450mm - 2x35L - Con tapa

Alto(mm)	Anch(mm)	Prof(mm)
650	405	570





CANASTILLA PARA CAÑERÍA | NANO / VIDRIO

Cierre Lento



598013

Módulo 800mm - SCK-80

Alto(mm)	Anch(mm)	Prof(mm)
180	750	435

598014

Módulo 900mm - SCK-90

Alto(mm)	Anch(mm)	Prof(mm)
180	870	435

CANASTILLA PARA CAÑERÍA | NANO / VIDRIO

Cierre Lento



598016

Módulo 900mm - SCZ-90

Alto(mm)	Anch(mm)	Prof(mm)
180	870	435

598017

Módulo 800mm - SCZ-80

Alto(mm)	Anch(mm)	Prof(mm)
180	770	435



CANASTILLA DE RATAN | XYH-06
Cierre Lento



598009

Módulo 800mm - Closet

Alto(mm)	Anch(mm)	Prof(mm)
200	765	450

598011

Módulo 600mm - Closet

Alto(mm)	Anch(mm)	Prof(mm)
180	570	450

CANASTILLA | G2022LL-2
Cierre lento



594025

Módulo 600mm - GC2 - Nano

Alto(mm)	Anch(mm)	Prof(mm)
155	565	535

594026

Módulo 400mm - GC3 - Nano

Alto(mm)	Anch(mm)	Prof(mm)
215	410	475

594027

Módulo 600mm - GC3 - Nano

Alto(mm)	Anch(mm)	Prof(mm)
210	565	535



ORGANIZADOR ESQUINA | NEGRO

590048



Módulo 800mm - 3 Niveles

Alto(mm)	Anch(mm)	Prof(mm)
1830	730	730



CANASTILLA | TDP-150A

594001



Módulo 150mm - Peso 6.4kg

Alto(mm)	Anch(mm)	Prof(mm)
435	115	440

CANASTILLA | TOM-150C

594002



Módulo 150mm - Peso 5.1kg

Alto(mm)	Anch(mm)	Prof(mm)
475	105	435

CANASTILLA | NANO

594034



Módulo 150mm

Alto(mm)	Anch(mm)	Prof(mm)
410	110	435

CANASTILLA | G2022LL-2

594030



Módulo 200mm - Izquierda - Nano

Alto(mm)	Anch(mm)	Prof(mm)
582	155	505

CANASTILLA | NANO

594035



Módulo 150mm - Derecha - CL

Alto(mm)	Anch(mm)	Prof(mm)
490	110	470

CANASTILLA | NANO

594036



Módulo 150mm - Izquierda - CL

Alto(mm)	Anch(mm)	Prof(mm)
490	110	470

CANASTILLA | S053132.300

594016



Módulo 300mm - Peso 4kg - Nano

Alto(mm)	Anch(mm)	Prof(mm)
550	265	445

CANASTILLA | TKM-300B

594020



Módulo 300mm - Hierro cromado

Alto(mm)	Anch(mm)	Prof(mm)
420	250	435

CANASTILLA | S051122.300B

594022



Módulo 300mm - Acero inoxidable

Alto(mm)	Anch(mm)	Prof(mm)
505	250	425

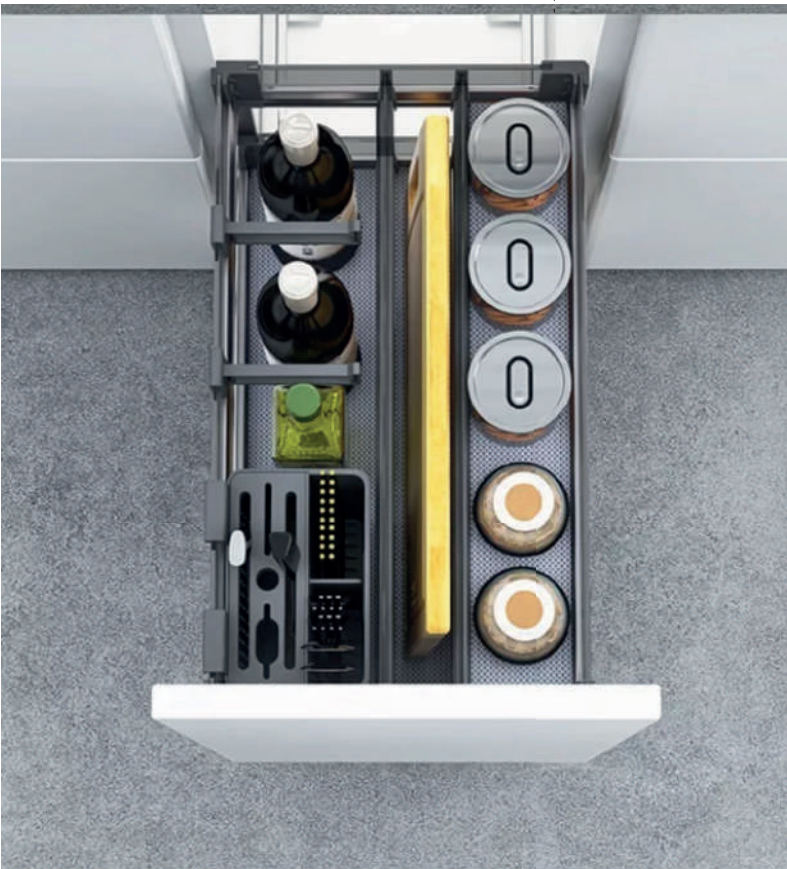

CANASTILLA | TOM-300A

594003



Módulo 300mm - Peso 7.1kg

Alto(mm)	Anch(mm)	Prof(mm)
500	225	435

CANASTILLA | G202511

594028



Módulo 350mm - Nano

Alto(mm)	Anch(mm)	Prof(mm)
472	309	480

CANASTILLA | TOM-350A

594004



Módulo 350mm - Peso 7.4kg

Alto(mm)	Anch(mm)	Prof(mm)
520	300	435



CANASTILLA | GBH-400

594032



Módulo 400mm - Nano

Alto(mm)	Anch(mm)	Prof(mm)
535	335	490

CANASTILLA | 501022

598012



Módulo 400mm - Cierre lento

Alto(mm)	Anch(mm)	Prof(mm)
475	390	465

CANASTILLA | TVH-400D-195

594015



Módulo 400mm - Peso 6kg - Nano

Alto(mm)	Anch(mm)	Prof(mm)
510	335	470

CANASTILLA | TVH-450G

594010



Módulo 450mm - 2 niveles - Nano

Alto(mm)	Anch(mm)	Prof(mm)
500	400	500

CANASTILLA | TVH-450G

594011



Módulo 450mm - 3 niveles - Nano

Alto(mm)	Anch(mm)	Prof(mm)
600	400	500

CANASTILLA | SC45G

594012



Módulo 450mm - 3 niveles - Acero

Alto(mm)	Anch(mm)	Prof(mm)
500	400	400



CANASTILLA | S051122.450B

594023



Módulo 450mm - Acero inoxidable

Alto(mm)	Anch(mm)	Prof(mm)
500	400	425

CANASTILLA | S053132.450

594017



Módulo 450mm - Peso 4kg - Nano

Alto(mm)	Anch(mm)	Prof(mm)
545	400	450

CANASTILLA | L503004

594019



Módulo 450mm - 3 niveles - Nano

Alto(mm)	Anch(mm)	Prof(mm)
470	415	425

CANASTILLA | G20251G

594029



Módulo 450mm - Nano

Alto(mm)	Anch(mm)	Prof(mm)
472	409	480

REPISA PARED | 3 NIVELES

593302



Peso máximo 5.8Kg

Alto(mm)	Anch(mm)	Prof(mm)
620	405	210



DESPENSA | TGM-455

599032



Módulo 450mm - Peso 21kg - 5 niveles

Alto(mm)	Anch(mm)	Prof(mm)
1620-1920	365	530

DESPENSA | PESO 6KG

Nano/ Vidrio



594107

Módulo 450mm - 2 niveles

Alto(mm)	Anch(mm)	Prof(mm)
550	370	440

594108

Módulo 500mm - 2 niveles

Alto(mm)	Anch(mm)	Prof(mm)
550	520	440

DESPENSA | S40122.604

594105



Módulo 600mm - 4 niveles - Nano

Alto(mm)	Anch(mm)	Prof(mm)
1240	540	460

DESPENSA | S40122.605

594106



Módulo 600mm - 5 niveles - Nano

Alto(mm)	Anch(mm)	Prof(mm)
1540	540	460



DESPENSA | NANO / MADERA
Cierre Lento



599037

Módulo 450mm - 5 niveles - G204110G-5

Alto(mm)	Anch(mm)	Prof(mm)
1364-1564	414	520

594109

Módulo 600mm - 5 niveles - G204110D-5

Alto(mm)	Anch(mm)	Prof(mm)
1364-1564	564	520

DESPENSA | G204110D-2

594110



599038

Módulo 450mm - 2 niveles - G204110G-2

Alto(mm)	Anch(mm)	Prof(mm)
660	414	520

594110

Módulo 600mm - 2 niveles - G204110D-2

Alto(mm)	Anch(mm)	Prof(mm)
660	564	520



DESPENSA | GDM-455

599035



Módulo 450mm - Peso 14kg- C/lento

Alto(mm)	Anch(mm)	Prof(mm)
1550-1850	395	505

DESPENSA | TDM-505

594102

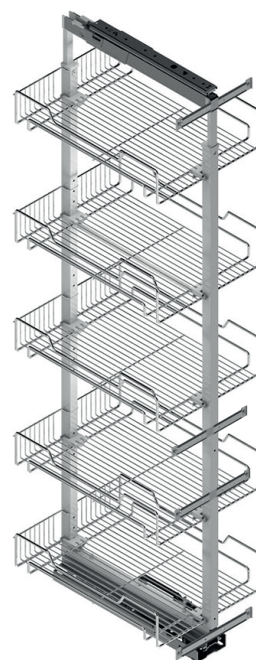

Módulo 500mm - Extraible - 5 niveles

Alto(mm)	Anch(mm)	Prof(mm)
1510-1860	445	485



DESPENSA | NANO
Cierre Lento



DESPENSA | G20212M-5

594111



Módulo 150mm - 5 niveles - Extraíble

Alto(mm)	Anch(mm)	Prof(mm)
1724-1424	90	470

DESPENSA | NANO
Cierre Lento - Extraíble



599030

Módulo 450mm - 4 niveles - KVM-454

Alto(mm)	Anch(mm)	Prof(mm)
1290-1640	380	480

599036

Módulo 450mm - 5 niveles - KVM-455

Alto(mm)	Anch(mm)	Prof(mm)
1550-1900	380	480

599039

Módulo 400mm - 6 niveles - G20212H-6

Alto(mm)	Anch(mm)	Prof(mm)
1984-1684	340	470

599041

Módulo 400mm - 5 niveles - G20212H-5

Alto(mm)	Anch(mm)	Prof(mm)
1724-1424	340	470

594142

Módulo 400mm - 4 niveles - G20212H-4

Alto(mm)	Anch(mm)	Prof(mm)
1464-1164	340	470

ORGANIZADOR AEREO | NANO / VIDRIO

Con regulador de descarga



593204

Módulo 800mm - Cierre lento

Alto(mm)	Anch(mm)	Prof(mm)
545	770	255

593205

Módulo 900mm - Cierre lento

Alto(mm)	Anch(mm)	Prof(mm)
545	870	255

ORGANIZADOR AEREO | HIERRO CROMADO

593201



Módulo 700mm - Peso 14.5kg - CL

Alto(mm)	Anch(mm)	Prof(mm)
560	665	280





CUBERTERO | ALUMINIO

590063



Módulo 700mm

Alto(mm)	Anch(mm)	Prof(mm)
60	650	460

CUBERTERO 3 LADOS | NANO / MADERA
G20445a



596247

Módulo 900mm

Alto(mm)	Anch(mm)	Prof(mm)
134	864	463

596248

Módulo 800mm

Alto(mm)	Anch(mm)	Prof(mm)
134	764	463

596249

Módulo 600mm

Alto(mm)	Anch(mm)	Prof(mm)
134	564	463

OLLERO 4 LADOS | NANO / MADERA
G20443a



595213

Módulo 900mm

Alto(mm)	Anch(mm)	Prof(mm)
84	864	466

595214

Módulo 800mm

Alto(mm)	Anch(mm)	Prof(mm)
84	764	466

595215

Módulo 600mm

Alto(mm)	Anch(mm)	Prof(mm)
84	564	466



OLLERO 3 LADOS | HIERRO CROMADO

Cierre Lento - TDS



596252

Módulo 600mm - Peso 10.5Kg

Alto(mm)	Anch(mm)	Prof(mm)
150	565	440

596253

Módulo 800mm - Peso 12.6Kg

Alto(mm)	Anch(mm)	Prof(mm)
150	665	440

596254

Módulo 900mm - Peso 14.2Kg

Alto(mm)	Anch(mm)	Prof(mm)
150	765	440

OLLERO 3 LADOS | HIERRO CROMADO

Cierre Lento - S10412

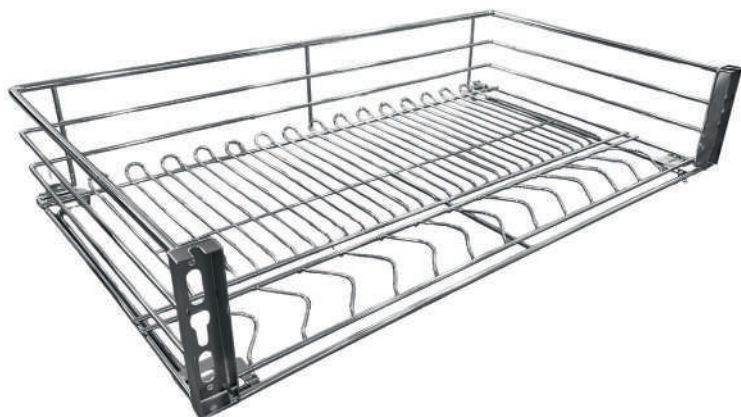

596240

Módulo 600mm - Peso 10.5Kg

Alto(mm)	Anch(mm)	Prof(mm)
150	565	440

596241

Módulo 800mm - Peso 11.2Kg

Alto(mm)	Anch(mm)	Prof(mm)
150	765	440

596242

Módulo 900mm - Peso 12.1Kg

Alto(mm)	Anch(mm)	Prof(mm)
150	865	440

OLLERO 3 LADOS | ACERO INOXIDABLE

Cierre Lento - S10412.603ss

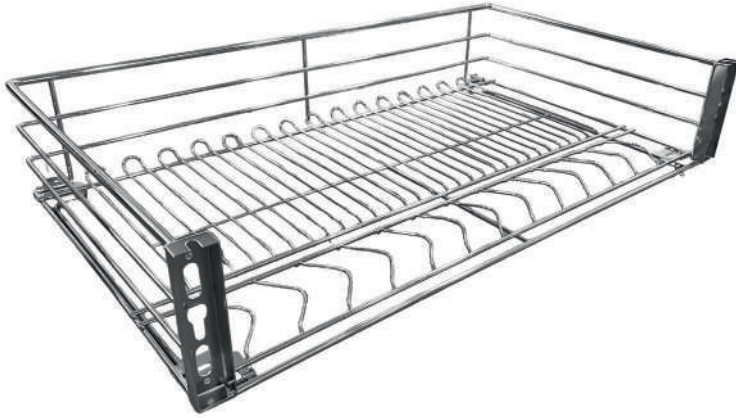

595225

Módulo 600mm - Peso 10.5Kg

Alto(mm)	Anch(mm)	Prof(mm)
150	565	440

595226

Módulo 800mm - Peso 11.2Kg

Alto(mm)	Anch(mm)	Prof(mm)
150	765	440

595227

Módulo 900mm - Peso 12.1Kg

Alto(mm)	Anch(mm)	Prof(mm)
150	865	440

OLLERO 4 LADOS | NANO

Cierre Lento - TVF



596245

Módulo 600mm - Peso 15Kg

Alto(mm)	Anch(mm)	Prof(mm)
160	570	450

596246

Módulo 800mm - Peso 15Kg

Alto(mm)	Anch(mm)	Prof(mm)
165	770	465

VAJILLERO 3 LADOS | HIERRO CROMADO

Cierre Lento - TDS

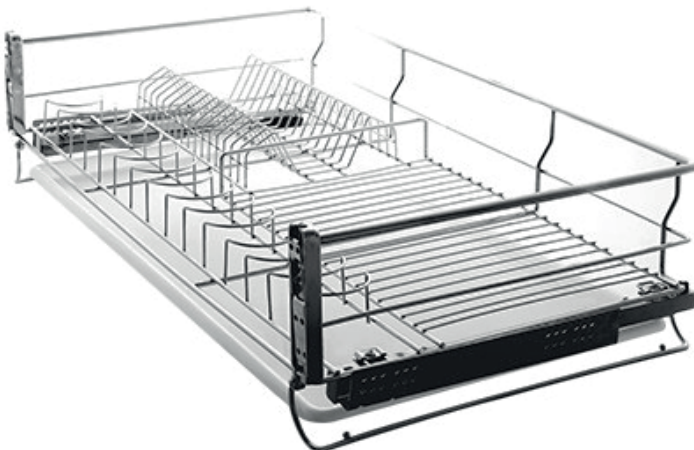

595200

Módulo 600mm - Peso 10.5Kg

Alto(mm)	Anch(mm)	Prof(mm)
150	565	440

595201

Módulo 800mm - Peso 12.1Kg

Alto(mm)	Anch(mm)	Prof(mm)
150	765	440

595202

Módulo 900mm - Peso 14.5Kg

Alto(mm)	Anch(mm)	Prof(mm)
150	865	440

VAJILLERO 3 LADOS | HIERRO CROMADO

Cierre Lento - S10422

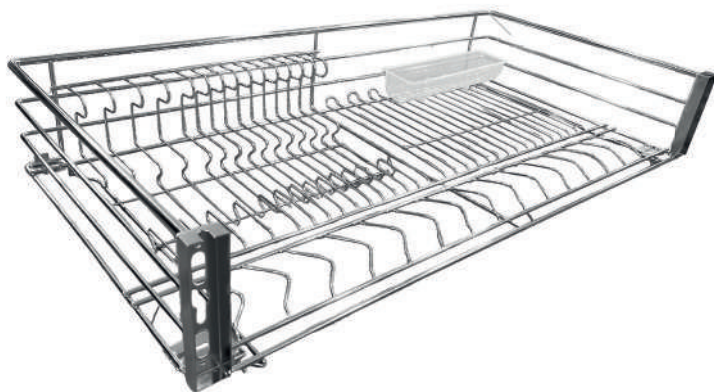

595220

Módulo 600mm - Peso 10.5kg

Alto(mm)	Anch(mm)	Prof(mm)
150	565	440

595221

Módulo 800mm - Peso 12.1kg

Alto(mm)	Anch(mm)	Prof(mm)
150	765	440

595222

Módulo 900mm - Peso 14.5kg

Alto(mm)	Anch(mm)	Prof(mm)
150	865	440

VAJILLERO 3 LADOS | ACERO INOXIDABLE

Cierre Lento - S10422.SS

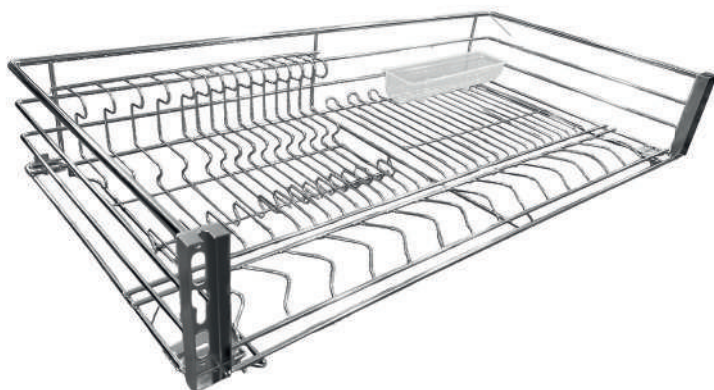

595219

Módulo 600mm - Peso 10.5kg

Alto(mm)	Anch(mm)	Prof(mm)
150	565	440

595223

Módulo 800mm - Peso 12.1kg

Alto(mm)	Anch(mm)	Prof(mm)
150	765	440

595224

Módulo 900mm - Peso 14.5kg

Alto(mm)	Anch(mm)	Prof(mm)
150	865	440

VAJILLERO 4 LADOS | HIERRO CROMADO

Cierre lento - TOT

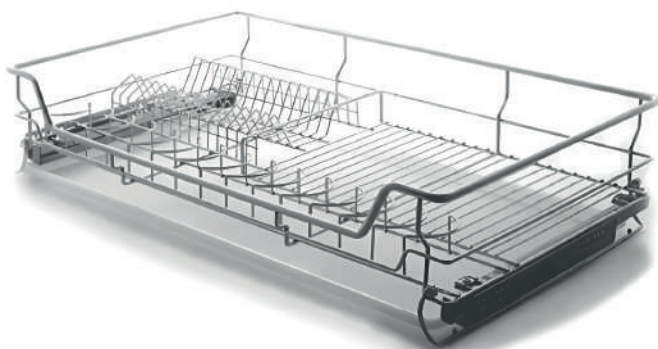

595210

Módulo 600mm - Peso 11.2kg

Alto(mm)	Anch(mm)	Prof(mm)
130	565	440

595211

Módulo 800mm - Peso 13.5kg

Alto(mm)	Anch(mm)	Prof(mm)
130	765	440

595212

Módulo 900mm - Peso 14.6kg

Alto(mm)	Anch(mm)	Prof(mm)
130	865	440



VAJILLERO 3 LADOS | ACERO INOXIDABLE

Peso 4kg - S0321122



595216

Módulo 600mm - Cierre lento

Alto(mm)	Anch(mm)	Prof(mm)
165	570	430

595217

Módulo 800mm - Cierre lento

Alto(mm)	Anch(mm)	Prof(mm)
165	770	430

595218

Módulo 900mm - Cierre lento

Alto(mm)	Anch(mm)	Prof(mm)
165	870	430

OLLERO 3 LADOS | ACERO INOXIDABLE

Peso 4kg - S031122



595206

Módulo 600mm - Cierre lento

Alto(mm)	Anch(mm)	Prof(mm)
165	570	430

595207

Módulo 800mm - Cierre lento

Alto(mm)	Anch(mm)	Prof(mm)
165	770	430

595208

Módulo 900mm - Cierre lento

Alto(mm)	Anch(mm)	Prof(mm)
165	870	430



ESQUINA MÁGICA | ACERO

590034

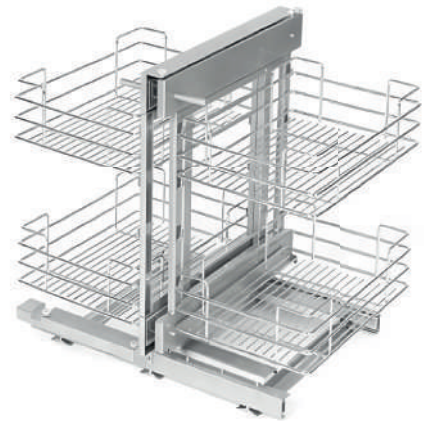

Módulo 900mm

Alto(mm)	Anch(mm)	Prof(mm)
590	660	490



ESQUINA MÁGICA | NANO/MADERA

591022



Módulo 600mm

Alto(mm)	Anch(mm)	Prof(mm)
592	600-830	455

ESQUINA MÁGICA | NANO/MADERA

594216



Módulo 600mm

Alto(mm)	Anch(mm)	Prof(mm)
592	600-830	455



TORNO GIRATORIO | HIERRO CROMADO

597103

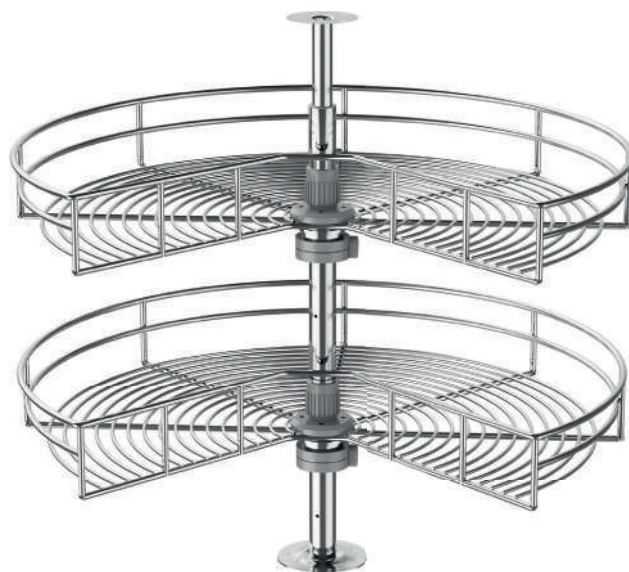

Módulo 800mm

Alto(mm)	Anch(mm)	Prof(mm)
770	710	750



TORNO GIRATORIO | HIERRO CROMADO

597102



Módulo 550mm

Alto(mm)	Anch(mm)	Prof(mm)
565	790	450



TORNO GIRATORIO | NANO

597104



Módulo 800mm

Alto(mm)	Anch(mm)	Prof(mm)
770	710	750



TORNO GIRATORIO | NANO

597106



Módulo 800mm

Alto(mm)	Anch(mm)	Prof(mm)
640	710	710



NELSON

HERRAJES / MAQUINARIA

CÓDIGO	NOMBRE	ANCHO	LARGO	MARCA	CARTÓN
020101	COVER FILM	45CM/15MM	25MT	NELSON	70
020102	COVER FILM	55CM/19MM	25MT	NELSON	70
020103	COVER FILM	65CM/16MM	25MT	NELSON	70
020104	COVER FILM	90CM/16MM	25MT	NELSON	35
020105	COVER FILM	110CM/16MM	25MT	NELSON	35
020106	COVER FILM	140CM/19MM	25MT	NELSON	35
020107	COVER FILM	270CM/16MM	25MT	NELSON	35
020108	COVER FILM	65CM/19MM	25MT	NELSON	70
020109	COVER FILM	90CM/19MM	25MT	NELSON	35
020116	COVER FILM	270CM/19MM	25MT	NELSON	35
020117	COVER FILM	110CM/19MM	25MT	NELSON	35
020120	COVER FILM	140CM/16MM	25MT	NELSON	35
020126	COVER FILM	55CM/16MM	25MT	NELSON	70



AUTO

GENERAL

CÓDIGO	NOMBRE	MM X YDS	TIPO	COLOR	MARCA	MASTER
020121	CINTA MASKING	19X40	AUTO	AMARILLO	NELSON	48
020122	CINTA MASKING	19X40	GENERAL	BLANCO	NELSON	48
020124	CINTA MASKING	25X40	GENERAL	BLANCO	NELSON	90
020123	CINTA MASKING	25X40	AUTO	AMARILLO	NELSON	90

CÓDIGO	NOMBRE	MM X YDS	TIPO	COLOR	MARCA
020129	CINTA ELÉCTRICA	19X10	GENERAL	NEGRO	NELSON
020130	CINTA ELÉCTRICA	19X20	GENERAL	NEGRO	NELSON



CÓDIGO	NOMBRE	MM X YDS	COLOR	CARTÓN	MARCA
020127	CINTA EMPAQUE	48X40	TRANSPARENTE	CRT 54	NELSON
020128	CINTA EMPAQUE	48X80	TRANSPARENTE	CRT 54	NELSON
020119	CINTA EMPAQUE	48X100	TRANSPARENTE	CRT 54	NELSON
020100	CINTA EMPAQUE	48X200	TRANSPARENTE	CRT 36	NELSON

CÓDIGO	NOMBRE	MM X YDS	COLOR	MARCA	MASTER
020132	CINTA DOBLE FAZ	12X2	AMARILLA	NELSON	740
020133	CINTA DOBLE FAZ	12X5	AMARILLA	NELSON	387
020134	CINTA DOBLE FAZ	18X2	AMARILLA	NELSON	464
020135	CINTA DOBLE FAZ	18X5	AMARILLA	NELSON	261/288
020136	CINTA DOBLE FAZ	18x5	AMARILLA	NELSON	288



020113

CINTA DE EMPAQUE

MEDIDAS	48MM/100YD
COLOR	CAFÉ
MARCA	NELSON



CINTA DE DUCTO

CÓDIGO	NOMBRE	MEDIDA	CARTÓN	MARCA
020114	CINTA DUCTO	48MM/10M	54	NELSON
020115	CINTA DUCTO	48MM/40M	36	NELSON



020131

CINTA COVER PROTECTOR PINTAR

MEDIDAS	4 X 5 M
MARCA	NELSON
MASTER	50



020807

CINTA GYPSUM

ANCHO	48 MM
LARGO	90 MT
MARCA	NELSON



021624

CINTA DOBLE FAZ

MEDIDAS	1 MM X 50 MM
LARGO	5MT
MARCA	NELSON



020111

CINTA COVER FILM OVERSPRAY

MEDIDAS	4.5 X 100 M
LARGO	
MARCA	NELSON

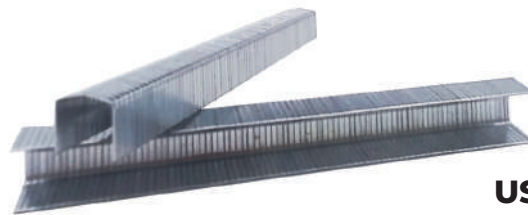
Ancho Exterior
11.4mm**USO INVERNADERO**

CÓDIGO	NOMBRE	MODELO MM	MARCA	CARTÓN
021582	GRAPA	50x19	NELSON	20

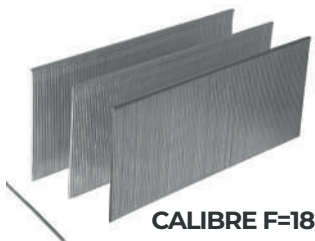

CALIBRE F=18

CÓDIGO	NOMBRE	CALIBRE LARGO MM	PULGADAS	MARCA	MASTER	CAJITA
021501	CLAVILLO	18/15MM	5/8	NELSON	20	5000
021502	CLAVILLO	18/20MM	3/4	NELSON	20	5000
021503	CLAVILLO	18/25MM	1	NELSON	20	5000
021504	CLAVILLO	18/30MM	1-1/4	NELSON	20	5000
021505	CLAVILLO	18/38MM	1-1/2	NELSON	12	5000
021506	CLAVILLO	18/50MM	2	NELSON	12	5000

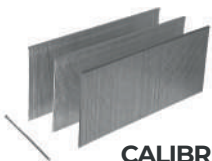

CALIBRE T=16

CÓDIGO	NOMBRE	MEDIDA	PULGADAS	MARCA	MASTER	CAJITA
021531	CLAVILLO	T19	3/4	NELSON	18	2500
021532	CLAVILLO	T25	1	NELSON	18	2500
021533	CLAVILLO	T29	1-1/4	NELSON	12	2500

CÓDIGO	NOMBRE	MEDIDA	MARCA	MASTER	CAJITA
021535	CLAVILLO PUNTILLA 612	1/2	NELSON	48	10000
021536	CLAVILLO PUNTILLA 620	3/4	NELSON	48	10000
021537	CLAVILLO PUNTILLA 625	1	NELSON	48	10000



CÓDIGO	NOMBRE	CALIBRE LARGO MM	PULGADAS	MARCA	PALET
021541	CLAVO HELICOIDAL	38MM	1-1/2	NELSON	64-30
021543	CLAVO HELICOIDAL	57MM	2-1/4	NELSON	40/50-30
021544	CLAVO HELICOIDAL	50MM	2PG	NELSON	30
021545	CLAVO HELICOIDAL	75MM	3PG	NELSON	30

CÓDIGO	NOMBRE	TIPO	REF.	MARCA	CARTÓN
021552	GRAPA	155X25	N825	NELSON	10000
021553	GRAPA	155X38	N838	NELSON	10000
021554	GRAPA	155X50	N850	NELSON	10000

 Ancho Exterior
10.8mm

Utilizada para armar estructuras de muebles de sala, reemplazando al clavo convencional.

 Ancho Exterior
71= 9mm
80= 12.8mm
84= 12.3mm

CÓDIGO	NOMBRE	MODELO MM	MARCA	CARTÓN
021561	GRAPA	71X10	NELSON	20
021571	GRAPA	80X10	NELSON	20
021573	GRAPA	80X8	NELSON	20
021581	GRAPA	84X10	NELSON	20

CÓDIGO	NOMBRE	TIPO	MEDIDA	MARCA	CARTÓN
021572	GRAPA AUTOMOTRIZ	C24	1.8 MM	NELSON	4-10000

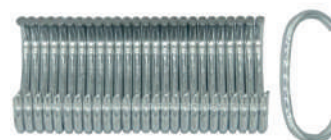

CÓDIGO	NOMBRE	TIPO	REF.	MARCA	CARTÓN
021590	GRAPA	90X19	L11	NELSON	10-5000
021591	GRAPA	90X25	L13	NELSON	10-5000
021592	GRAPA	90X29	L14	NELSON	10-5000
021593	GRAPA	90X38	17	NELSON	10-5000

 Ancho Exterior
5.7mm

Utilizado en carpintería para el armazón de cajonería como en closets, etc. También para armar tendidos de cama.

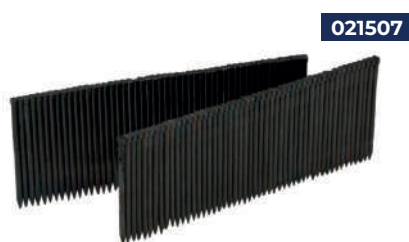
CLAVILLO CONCRETO

LARGO	35MM
MASTER	10
CAJITA	1500
MARCA	NELSON

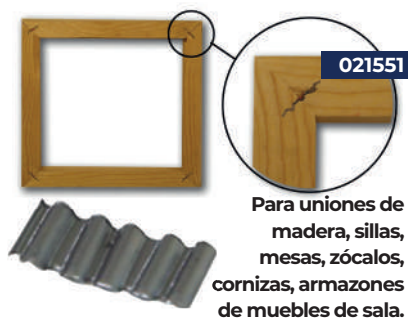
 Para uniones de
 madera, sillas,
 mesas, zócalos,
 cornizas, armazones
 de muebles de sala.

GRAPA CORRUGADA

MEDIDA	1/2
CARTÓN	4000
PESO	22 KLS
MARCA	NELSON

CINTA MELÁLICA

ROLLO	20 MTS
MASTER	20
REF.	
MARCA	NELSON



CÓDIGO	NOMBRE	MEDIDA	REF.	FUNDA
023501	TARUGO	10X40MM	QA2001	CRT10000-1000
023502	TARUGO	12X40MM	QA2001	CRT10000-1000
023504	TARUGO	12X30MM	QA2001	CRT10000-1000
023509	TARUGO	8X40MM	QA2001	VCRT10000-1000



150010

GALLETA LAMELLO

PRES.	20 FUD-1000
REF.	144020
MARCA	NELSON

**SIMBRA ZIGZAG**

CÓDIGO	NOMBRE	MEDIDA	CARTÓN	MARCA
020142	ZIGZAG	3 MM	20 MTS	NELSON
020143	ZIGZAG	3.5 MM	20 MTS	NELSON

CÓDIGO	NOMBRE	MEDIDA	TIPO	ROLLO	CRT	MARCA
0228001	ZANGLATEX	5CM	PESADO	50 MTS	50	NELSON
0228004	ZANGLATEX	4.5CM	NORMAL	50 MTS	50	NELSON
0228005	ZANGLATEX	6CM	EXTRA PESADO	50 MTS	50	NELSON
0228007	ZANGLATEX	4.5CM		50 MTS	50	NELSON



023305

RESBALON

TIPO	S/CAUCHO
REF.	YC3001
COLOR	CAFÉ
MASTER	5000-1000
MARCA	NELSON



023306

RESBALON

TIPO	C/CAUCHO
REF.	1r10301
COLOR	BLANCO/NEGRO
MASTER	Crt50-100Und.
MARCA	NELSON



023303

RESBALON 22MM

TIPO	C/CAUCHO
REF.	YC3001
COLOR	CAFÉ/NEGRO
MASTER	Crt5000-500Und.
MARCA	NELSON

ESPECIFICACIÓN

(165°)

Bisagras utilizadas en puertas esquineras para muebles del hogar (modulares). Son invisibles desde fuera del mueble, cierran solas a partir de un cierto ángulo, desmontables y regulables.



HG1165A

HG1165B

CÓDIGO	NOMBRE	CAZOleta	REF.	MARCA	MASTER	FUNDA
020301	BISAGRA CANGREJO SEMICODO	35MM	HG1165B	NELSON	100	2 UNID
020612	BISAGRA CANGREJO RECTA	35MM	LH165A	NELSON	100	2 UNID

CÓDIGO	NOMBRE	CAZOLETA	REF.	MARCA	MASTER	FUNDA
020608	BISAGRA RECTA	35MM	LH261A	NELSON	100	2 UNID
020809	BISAGRA SEMICODO	35MM	LH261B	NELSON	100	2 UNID
020609	BISAGRA CODO	35MM	LH261C	NELSON	100	2 UNID



HG2603A

HG2601B

CÓDIGO	NOMBRE	CAZOLETA	REF.	MASTER	FUNDA
020603	BISAGRA MINIRECTA	26MM	LH2603A-HG2601A	125	2 UNID
020803	BISAGRA MINISEMICODO	26MM	LH2603B-HG2601B	125	2 UNID



BISAGRA (105°) HIDRAÚLICA

CÓDIGO	NOMBRE	CAZOLETA	TIPO	REF.	MARCA	MASTER	FUNDA
020610	BISAGRA RECTA	35MM	HIDRAULICA	3001r	NELSON	100	2 UNID
020613	BISAGRA SEMICODO	35MM	HIDRAULICA	3002s	NELSON	100	2 UNID



CÓDIGO	NOMBRE	REF.	COLOR	MARCA	FUNDA
023602	TOPE DE ENGRAMPE	GXM23	NIQ	NELSON	1000-100
023603	TOPE DE ENGRAMPE	GXM23	COBRE	NELSON	1000-100

(135°)



020611

LH135A

BISAGRA CORNER

CAZOLETA	35MM
REF.	LH135A
MASTER	100
FUNDA	2 UNID
MARCA	NELSON

020600



BISAGRA

MEDIDA	33mm
TIPO	PUSH
REF.	MT0400+PISTON DAMPER
MARCA	NELSON

020215



BISAGRA

MEDIDA	3X3"/2mm
TIPO	C/RULIMAN
COLOR	SN
MARCA	NELSON

ESPECIFICACIÓN

Bisagra cuadrada de Acero utilizada especialmente en puertas con batiente.

CÓDIGO	NOMBRE	PULGADA	REF.	COLOR	MARCA	CARTÓN	FUNDA
020201	BISAGRA	3X3"/1.4mm	-	AB	NELSON	100	2 UNID
020202	BISAGRA	3X3"/1.4mm	-	NEGRO	NELSON	60	3 UNID
020203	BISAGRA	3X3"/1.4mm	HM301	SN	NELSON	60	3 UNID
020206	BISAGRA	3.5X3.5"/1.4mm	MH301	AB	NELSON	40	3 UNID
020211	BISAGRA	3.5X3.5"/1.4mm	HM301	SN	NELSON	40	3 UNID
020214	BISAGRA	3X3"/1.8mm	-	NEGRO	NELSON	60	3 UNID



020910

Bisagra pivote reforzada utilizada para puertas de entrada del hogar.

BISAGRA PIVOTE	
REF.	MT0533
FUNDA	1 UNID
MASTER	30
MARCA	NELSON

ESPECIFICACIÓN

Bisagra de doble acción para puertas de madera



CÓDIGO	NOMBRE	PULG.	REF.	COLOR	MASTER	FUNDA	MARCA
020901	BISAGRA VAIVEN	3"	MT1101-3	NEGRO	25	2 UNID	NELSON
020902	BISAGRA VAIVEN	4"	MT1104-M	NEGRO	25	2 UNID	NELSON

CÓDIGO	NOMBRE	MED.	COLOR	MARCA	MASTER	CAJITA
020701	BISAGRA REFORZADA	1-1/2"	NIQ	NELSON	80	12 UNID
020700	BISAGRA REFORZADA	2"	NIQ	NELSON		12 UNID
020702	BISAGRA REFORZADA	2-1/2"	NIQ	NELSON	40	12 UNID
020703	BISAGRA REFORZADA	3"	NIQ	NELSON	20	12 UNID
020707	BISAGRA REFORZADA	3-112	NIQ	NELSON	20	12 UNID
020704	BISAGRA REFORZADA	4"	NIQ	NELSON	20	6 UNID



INSTALACIÓN

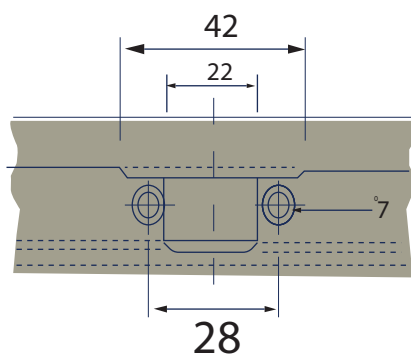

RECTA

CÓDIGO	NOMBRE	PERFORACIÓN	TIPO	REF.	MASTER	FUNDA
020618	BISAGRA ALUMINIO	42/22/28MM	HIDRAULICA RECTA	4001r	100	PAR

INSTALACIÓN

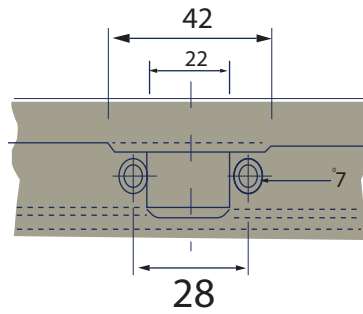
**SEMICODO**

CÓDIGO	NOMBRE	PERFORACIÓN	TIPO	REF.	MASTER	FUNDA
020619	BISAGRA ALUMINIO	42/22/28MM	HIDRAULICA SEMICODO	4002s	100	PAR

INSTALACIÓN

**SEMICODO**

CÓDIGO	NOMBRE	PERFORACIÓN	TIPO	REF.	MASTER	FUNDA
020617	BISAGRA VIDRIO	26MM	SEMICODO	2002s	125	PAR

INSTALACIÓN

**RECTA**

CÓDIGO	NOMBRE	PERFORACIÓN	TIPO	REF.	MASTER	FUNDA
020616	BISAGRA VIDRIO	26MM	RECTA	2001r	125	PAR

**(90°)**

CÓDIGO	NOMBRE	CAZOLETA	TIPO	REF.	MASTER	FUNDA
020615	BISAGRA LH90	35MM	90°	Lh90	100	PAR

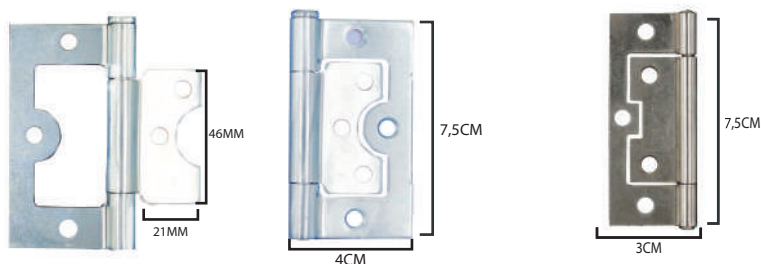

CÓDIGO	NOMBRE	PULGADA	REF.	COLOR	MARCA	CARTÓN	FUNDA
020302	BISAGRA OMEGA	3pulgadas X4cm/1.8mm		ZINC PUL.	NELSON	100	10 UNID
020303	BISAGRA OMEGA	3pulgadas X3cm/1.6mm	Xd8019	Dn Niq	NELSON	200	10 UNID



BISAGRA PIANO

MEDIDA	32MMX0.7MMX3.5MT
COLOR	DORADO
MASTER	CRT100
MARCA	NELSON



ESPECIFICACIÓN

Bisagras de presión utilizadas para gabinetes. Para todo tipo de mueble.

CÓDIGO	NOMBRE	REF.	COLOR	MARCA	MASTER	FUNDA
020502	BISAGRA PRESIÓN	HM191	AB BRONCE	NELSON	250	10 UNID
020503	BISAGRA PRESIÓN	HM191	AC COBRE	NELSON	250	10 UNID
020504	BISAGRA PRESIÓN	HM191	BP DORADO	NELSON	250	10 UNID
020505	BISAGRA PRESIÓN	HM191	SN SATINADA	NELSON	250	10 UNID



HERRAJE ABATIBLE SOFA-CAMA

CÓDIGO	NOMBRE	MEDIDA	REF.	COLOR	TIPO	CARTÓN	MARCA
021203	HERRAJE ABATIBLE	260mm	T4026	NEGRO	METAL	25/20PARES	NELSON
021224	HERRAJE ABATIBLE	260mm	T4a002	DORADO	METAL	20PARES	NELSON
021500	HERRAJE ABATIBLE	300mm	T4a002	NEGRO	METAL	25 PARES	NELSON



HERRAJE BRAZO MECANICO

CÓDIGO	NOMBRE	MEDIDA	REF.	USO	CARTÓN	MARCA
021223	BRAZO MECANICO	21.5cm	T4a007	MUEBLE	25PARES	NELSON
021209	BRAZO MECANICO	24cm	T4a007	MUEBLE	25PARES	NELSON

021207

**HERRAJE BAUL**

REF.	4a005 lzq-Der
MARCA	NELSON
CARTÓN	20pares
MEDIDA	58X9.3CM

021206

**HERRAJE BAUL**

REF.	4a004
MARCA	NELSON
CARTÓN	20pares
MEDIDA	22X17.5cm lzq-Der

021204

**Herraje Cabecera Mueble 90°**

REF.	Gm 093
COLOR	PLATEADO
MASTER	CRT 25 PARES
MARCA	NELSON

021248

**MECANISMO DE SOFÁ**

REF.	Zd-1010
MARCA	NELSON
CARTÓN	30 pares
MED	-

021252

**HERRAJE CABECERA**

REF.	Zd-J013
MARCA	NELSON
CARTÓN	25 pares
TIPO	6 POSICIONES(90-180°)

021249

**BRAZO RADICAL CON RESORTE**

REF.	Zd-H007-A
MARCA	NELSON
CARTÓN	60
TIPO	90-180

CÓDIGO	NOMBRE	LARGO	REF.	COLOR	MASTER
021401	CERRADURA VITRINA VIDRIO	D16-140MM	NF0328	NIQ	240
021440	CERRADURA VITRINA VIDRIO	D19-140MM	ZD-DL318	NIQ	240



CÓDIGO	NOMBRE	LARGO	REF.	COLOR	MASTER
021418	CERRADURA CAJON	D16-22MM	C101	NIQ	240
021435	CERRADURA PUSH	D19-32MM	C101	NIQ	240

CÓDIGO	NOMBRE	LARGO	REF.	COLOR	MASTER
021411	CERRADURA PUSH	D19-24MM	T11005	NIQ	240
021441	CERRADURA PUSH	D19-22MM	T11005	NIQ	240



021417

**CERRADURA VIDRIO CUADRADA**

REF.	T11007
MARCA	NELSON
CARTÓN	240-12
MEDIDA	20X20MM

021413

**CERRADURA VIDRIO RECTANGULAR**

REF.	T11006
MARCA	NELSON
CARTÓN	240-12
MEDIDA	50X35MM

021414

**CERRADURA CAJÓN**

REF.	T11004
MARCA	NELSON
CARTÓN	Crt240-12
MEDIDA	D22-22mm

CÓDIGO	NOMBRE	LARGO	REF.	COLOR	MARCA	MASTER	FUNDA
021400	CERRADURA PALETA	D19-16MM	T11009	NIQ	NELSON	240	12 UNID
021405	CERRADURA PALETA	D19-20MM	T11009	NIQ	NELSON	240	12 UNID
021408	CERRADURA PALETA	D19-25MM	T11009	NIQ	NELSON	240	12 UNID
021410	CERRADURA PALETA	D19-30MM	T11009	NIQ	NELSON	240	-

**ESPECIFICACIÓN**

Utiliza en todo tipo de muebles en general instalados frontalmente, cerradura push



CÓDIGO	NOMBRE	LARGO	REF.	COLOR	MARCA	MASTER	FUNDA
021402	CERRADURA CAJÓN	D19-38MM	137	NIQ	NELSON	240	12 UNID
021406	CERRADURA CAJÓN	D19-22MM	NF0138	NIQ	NELSON	240	12 UNID
021409	CERRADURA CAJÓN	D16-20MM	NF0136	NIQ	NELSON	240	12 UNID

021407

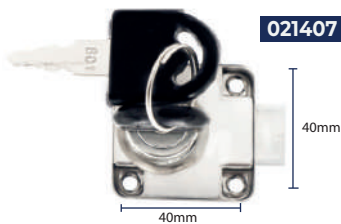
**CERRADURA CAJON**

LARGO	D19-22MM
REF.	C101
COLOR	NIQ
MASTER	CRT240-12
MARCA	NELSON

021415

**CERRADURA PICO LORO PISTILLO**

REF.	T11011
MARCA	NELSON
CARTÓN	50
MED	170X20MM

021416

**CERRADURA PICO LORO DOBLE LLAVE**

REF.	T11011
MARCA	NELSON
CARTÓN	50
MED	170X20MM



ESPECIFICACIÓN

Tiene un deslizamiento silencioso y uniforme gracias al juego de rulimanes internos. Permite la extensión completa del cajón hacia fuera del mueble.

CÓDIGO	NOMBRE	MED"	ANCHO	TIPO	REF.	COLOR	MARCA	MASTER	FUNDA
022007	RIEL	10	35MM	EXT	LS3501	ZING	NELSON	25	2
022001	RIEL	12	35MM	EXT	LS3501	ZING	NELSON	25	2
022002	RIEL	14	35MM	EXT	LS3501	ZING	NELSON	25	2
022003	RIEL	16	35MM	EXT	LS3501	ZING	NELSON	25	2
022004	RIEL	18	35MM	EXT	LS3501	ZING	NELSON	25	2
022005	RIEL	20	35MM	EXT	LS3501	ZING	NELSON	25	2
022006	RIEL	22	35MM	EXT	LS3501	ZING	NELSON	25	2
022020	RIEL	24	35MM	EXT	LS3501	ZING	NELSON	25	2
022140	RIEL	10	45MM	EXT	LS4501	ZING	NELSON	20	2
022033	RIEL	12	42MM	EXT	LS4201	ZING	NELSON	20	2
022034	RIEL	14	42MM	EXT	LS4201	ZING	NELSON	20	2
022035	RIEL	16	42MM	EXT	LS4201	ZING	NELSON	20	2
022036	RIEL	18	42MM	EXT	LS4201	ZING	NELSON	20	2
022030	RIEL	20	42MM	EXT	LS4201	ZING	NELSON	20	2
022041	RIEL	22	42MM	EXT	LS4201	ZING	NELSON	20	2
022037	RIEL	24	42MM	EXT	LS4201	ZING	NELSON	20	2
022122	RIEL	14	45MM	EXT	Ls4501	ZING	NELSON	20	2
022143	RIEL	16	45MM	EXT	Ls4501	ZINC	NELSON	20	2
022330	RIEL	18	45MM	EXT	Ls4501	ZINC	NELSON	20	2
022409	RIEL	20	45MM	EXT	Ls4501	ZINC	NELSON	20	2
022127	RIEL	22	45MM	ETX	Ls4501	ZINC	NELSON	20	2



ESPECIFICACIÓN

Riel ligera y silenciosa que facilita el abre fácil del cajón, permitiendo su extensión completa hacia fuera del mueble.

CÓDIGO	NOMBRE	MED.	ANCHO	TIPO	REF.	COLOR	MARCA	MASTER	FUNDA
022154	RIEL	12	45MM	EXT PUSH	4510	ZINC	NELSON	20	2
022150	RIEL	14	45MM	EXT PUSH	1045	ZINC	NELSON	20	2
022151	RIEL	16	45MM	EXT PUSH	1045	ZINC	NELSON	20	2
022152	RIEL	18	45MM	EXT PUSH	1045	ZINC	NELSON	20	2
022153	RIEL	20	45MM	EXT PUSH	1045	ZINC	NELSON	20	2
022155	RIEL	22	45MM	EXT PUSH	1045	ZINC	NELSON	20	2
022156	RIEL	24	45MM	EXT PUSH	1045	ZINC	NELSON	20	2



ESPECIFICACIÓN

Riel ligera y silenciosa que permite el cierre suave sin rebote del cajón.

CÓDIGO	NOMBRE	MED.	ANCHO	TIPO	REF.	COLOR	MARCA	MASTER	FUNDA
021904	RIEL	14	45MM	EXT CIERRE LENTO	XL-B-4512	ZINC	NELSON	20	2
021905	RIEL	16	45MM	EXT CIERRE LENTO	SOFT 1045	ZINC	NELSON	20	2
021906	RIEL	18	45MM	EXT CIERRE LENTO	SOFT 1045	ZINC	NELSON	20	2
021907	RIEL	20	45MM	EXT CIERRE LENTO	SOFT 1045	ZINC	NELSON	20	2
021908	RIEL	24	45MM	EXT CIERRE LENTO	SOFT 1045	ZINC	NELSON	25	2
021909	RIEL	22	45	EXT CIERRE LENTO	SOFT 1045	ZINC	NELSON	20	2



ESPECIFICACIÓN

La riel se fija al lateral del mueble y el soporte al cajón. Cuenta con un sistema de dos rodillos nylon.

CÓDIGO	NOMBRE	MED"	TIPO	COLOR	REF.	LARGO	MARCA	MASTER	FUNDA
022108	RIEL	24	CAJON COMERCIAL	BLANCA	T6001	(600 MM)	NELSON	25	2 UNID
022301	RIEL	12	CAJON INDUSTRIAL	CREMA	DS801		NELSON	25	2 UNID
022306	RIEL	14	CAJON INDUSTRIAL	CREMA	DS801		NELSON	25	2 UNID
022310	RIEL	16	CAJON INDUSTRIAL	CREMA	DS801		NELSON	25	2 UNID
022315	RIEL	18	CAJON INDUSTRIAL	CREMA	DS801		NELSON	25	2 UNID
022318	RIEL	20	CAJON INDUSTRIAL	CREMA	DS801		NELSON	25	2 UNID
022321	RIEL	22	CAJON INDUSTRIAL	CREMA	DS801		NELSON	25	2 UNID
022323	RIEL	24	CAJON INDUSTRIAL	CREMA	DS801		NELSON	25	2 UNID

ESPECIFICACIÓN

Kit de Riel Oculta Soft

Combina un cierre silencioso con mecanismo de apertura fácil. Extensión Completa, totalmente oculta bajo cubierta diseño.

CÓDIGO	NOMBRE	PULGADAS	REF.	COLOR	MARCA	FUNDA
025000	RIEL OCULTA	18 Dmi	Soft Cl 18 Dmi-803sh	ZINC	NELSON	Par
025009	RIEL OCULTA	20 Dmi	Dmi-803sh Nelson Crt10	ZINC	NELSON	Par

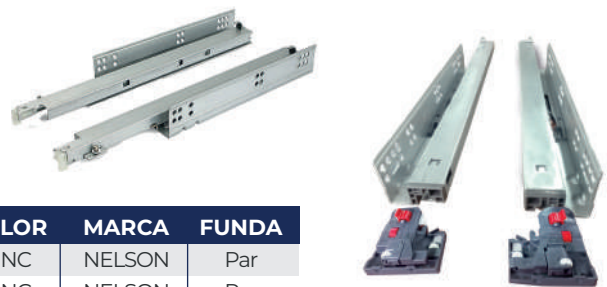

ESPECIFICACIÓN

Riel Oculta

CÓDIGO	NOMBRE	PULGADAS	REF.	COLOR	MARCA	FUNDA
025010	RIEL OCULTA	18 Dmi	Dmi-803ph Nelson Crt10	ZINC	NELSON	Par
025011	RIEL OCULTA	20 Dmi	Dmi-803ph Nelson Crt10	ZINC	NELSON	Par





ESPECIFICACIÓN

Para puertas corredizas 1 hoja

CÓDIGO	NOMBRE	LARGO	TIPO	REF.	COLOR	MARCA	CARTÓN
025002	RIEL AEREA	2MT	CORREDERA	MD199	ZINC	NELSON	10
025003	RIEL AEREA	3MT	CORREDERA	MD199	ZINC	NELSON	10



Riel Aerea Doble Aluminio

CÓDIGO	NOMBRE	LARGO	TIPO	REF.	COLOR	MARCA	CARTÓN
025004	RIEL AEREA	2MT	CORREDERA	MD1408	ZINC	NELSON	10
025005	RIEL AEREA	3MT	CORREDERA	MD1408	ZINC	NELSON	10



025001

Para
025002
025003



CORREDERA	
TIPO	AEREA
PESO	80 KILOS
REF.	MD199-1
MARCA	NELSON
CARTÓN	60
CAJA	1JUEGO 4UNI



025007

Para
025004
025005



CORREDERA	
TIPO	AEREA
PESO	MAX 30 KILOS
REF.	MD1408
MARCA	NELSON
CARTÓN	60
CAJA	1JUEGO 4UNI



025006



CORREDERA	
TIPO	AEREA
PESO	MAX 45 KILOS
REF.	MD188
MARCA	NELSON
CARTÓN	60
CAJA	1JUEGO 4UNI

CÓDIGO	NOMBRE	MEDIDA	COLOR	MARCA	CARTÓN
021630	NIVELADOR ZÓCALO	12CM	NEGRO	NELSON	200-4
021619	NIVELADOR ZÓCALO	10CM	NEGRO	NELSON	400-10
021629	NIVELADOR ZÓCALO	8CM	NEGRO	NELSON	400-10





021721

10 cm

PATA DE MUEBLE

ALTO	10cm - Ø5cm
REF.	T4003
COLOR	SN
MASTER	100
MARCA	NELSON



021743

5 cm

PATA DE MUEBLE

ALTO	5 CM
REF.	T4003
COLOR	SN
MASTER	100
MARCA	NELSON

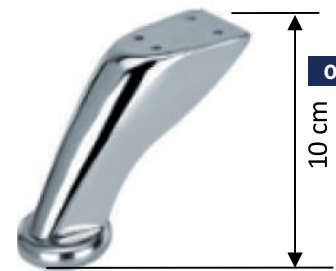

021723

10 cm

PATA DE MUEBLE

ALTO	10 CM
ESPESOR	1.2 MM
REF.	T4009
COLOR	SN
MASTER	100
MARCA	NELSON



021728

PARTE SUPERIOR

PARTE INFERIOR

4 cm

PATA MESA

LARGO	71 CM
DIÁMETRO	6 CM
REF.	C634T3006
COLOR	SN
MASTER	CRT 4 UN
MARCA	NELSON



021748

PATA DE MUEBLE

ALTO	10 CM
REF.	T4014
COLOR	
MASTER	100
MARCA	NELSON



021817

SOPORTE VIDRIO

REF.	MD4730
COLOR	NIQ
MASTER	100
MARCA	NELSON

**PATA MUEBLE
T4035**

CÓDIGO	NOMBRE	MEDIDA	REF.	COLOR	TIPO	CARTÓN	MARCA
021731	PATA DE MUEBLE	10 CM	T4035	CARAMELO	MADERADO	60	NELSON
021754	PATA DE MUEBLE	12 CM	T4035	CARAMELO	MADERADO	60	NELSON
021755	PATA DE MUEBLE	15 CM	T4035	CARAMELO	MADERADO	60	NELSON
021733	PATA DE MUEBLE	10 CM	T4035	NOGAL	MADERADO	60	NELSON
021756	PATA DE MUEBLE	15CM	T4035	NOGAL	MADERADO	60	NELSON
021705	PATA DE MUEBLE	10CM	T4035	HAYA	MADERADO	60	NELSON



PATA MUEBLE T4039

CÓDIGO	NOMBRE	MEDIDA	REF.	COLOR	TIPO	CARTÓN	MARCA
020605	PATA DE MUEBLE	10cm D5cm	T4039	CARAMELO	REGULABLE	100	NELSON
021841	PATA DE MUEBLE	10cm D5cm	T4039	NOGAL	REGULABLE	100	NELSON
021725	PATA DE MUEBLE	10cm D5cm	T4039	HAYA	REGULABLE	100	NELSON

PATA MUEBLE T4029



CÓDIGO	NOMBRE	MEDIDA	REF.	COLOR	TIPO	CARTÓN	MARCA
021761	PATA MUEBLE PUNTA	45 CM	T4029	NEGRO	METAL	30	NELSON
021777	PATA MUEBLE PUNTA	70 CM	T4029	NEGRO	METAL	20	NELSON



PATA MUEBLE T4026

CÓDIGO	NOMBRE	MEDIDA	REF.	COLOR	TIPO	CARTÓN	MARCA
021759	PATA DE MUEBLE	10cm Esp1.4mm	T4026	DORADO	METAL	100	NELSON
021760	PATA DE MUEBLE	15cm Esp1.4mm	T4026	DORADO	METAL	60	NELSON

PATA MUEBLE T4025



CÓDIGO	NOMBRE	MEDIDA	REF.	COLOR	TIPO	CARTÓN	MARCA
021736	PATA DE MUEBLE	10 CM	T4025	NEGRO	METAL	60	NELSON
021764	PATA DE MUEBLE	25 CM	T4025	NEGRO	METAL	60	NELSON
021768	PATA DE MUEBLE	45 CM	T4025	NEGRO	METAL	30	NELSON
021769	PATA DE MUEBLE	70 CM	T4025	NEGRO	METAL	30	NELSON

PATA MUEBLE T4025



CÓDIGO	NOMBRE	MEDIDA	REF.	COLOR	TIPO	CARTÓN	MARCA
021751	PATA DE MUEBLE	10 CM	T4025	DORADO	METAL	60	NELSON
021752	PATA DE MUEBLE	12 CM	T4025	DORADO	METAL	60	NELSON
021753	PATA DE MUEBLE	15 CM	T4025	DORADO	METAL	60	NELSON
021765	PATA DE MUEBLE	25 CM	T4025	DORADO	METAL	60	NELSON
021766	PATA DE MUEBLE	45 CM	T4025	DORADO	METAL	30	NELSON
021767	PATA DE MUEBLE	70 CM	T4025	DORADO	METAL	30	NELSON

PATA MUEBLE T4025



CÓDIGO	NOMBRE	MEDIDA	REF.	COLOR	TIPO	CARTÓN	MARCA
021770	PATA DE MUEBLE	10 CM	T4025	NEG/DOR	METAL	60	NELSON
021771	PATA DE MUEBLE	15 CM	T4025	NEG/DOR	METAL	60	NELSON
021798	PATA DE MUEBLE	25 CM	T4025	NEG/DOR	METAL	60	NELSON
021772	PATA DE MUEBLE	45 CM	T4025	NEG/DOR	METAL	30	NELSON
021773	PATA DE MUEBLE	70 CM	T4025	NEG/DOR	METAL	30	NELSON



PATA MUEBLE T4007

CÓDIGO	NOMBRE	MEDIDA	REF.	MARCA
021842	PATA DE MUEBLE	10CM - Ø5cm	T4007	NELSON



PATA MUEBLE PLASTIC C/PERNO REDOND	
REF.	T16005
MARCA	NELSON
CARTÓN	Crt192
MEDIDA	15CM
COLOR	NEGRO



CÓDIGO	NOMBRE	REF.	COLOR	MARCA	CARTÓN
021807	SOPORTE REPISA	T06	BLANCO	NELSON	5000-1000
021808	SOPORTE REPISA	T06	CAFE	NELSON	5000-1000
021809	SOPORTE REPISA	T06	TRANSP	NELSON	5000-1000



CÓDIGO	NOMBRE	MEDIDA	REF.	COLOR	MARCA	MASTER
021811	SOPORTE ESTRUCT	20X15	WC0015	GALV	NELSON	3600-100
021812	SOPORTE ESTRUCT	25X15	WC0015	GALV	NELSON	3000-100
021813	SOPORTE ESTRUCT	30X15	WC0015	GALV	NELSON	2600-100
021814	SOPORTE ESTRUCT	40X15	WC0015	GALV	NELSON	1600-100
021815	SOPORTE ESTRUCT	50X15	WC0015	GALV	NELSON	1000-100

SOPORTE UNIÓN	
REF.	Wc0008
MEDIDAS	37mm
MASTER	2000-100
MARCA	NELSON



CÓDIGO	NOMBRE	TIPO	REF.	REF.	MARCA	MASTER	PAQUETE
021601	NIVELADOR	12X25	QA3002	NIQ	NELSON	2500	10
021602	NIVELADOR	12X30	QA3002	NIQ	NELSON	2000 -250	10
021604	NIVELADOR	16X25	QA3002	NIQ	NELSON	1728-216	6
021605	NIVELADOR	16X30	QA3002	NIQ	NELSON	1440-180	6
021607	NIVELADOR	19X25	QA3002	NIQ	NELSON	1152-144	6
021608	NIVELADOR	19X30	QA3002	NIQ	NELSON	1024-128	4
021609	NIVELADOR	19X40	QA3002	NIQ	NELSON	752-94	4
021611	NIVELADOR	22X25	QA3002	NIQ	NELSON	736-92	4
021617	NIVELADOR	25X100	QA3002	NIQ	NELSON	168	
021618	NIVELADOR	25X25	QA3002	NIQ	NELSON	672-84	4
021620	NIVELADOR	25X30	QA3002	NIQ	NELSON	576-72	4
021622	NIVELADOR	25X40	QA3002	NIQ	NELSON	416-56	4
021623	NIVELADOR	25X50	QA3002	NIQ	NELSON	336	4
021625	NIVELADOR	25X70	QA3002	NIQ	NELSON	240	2
021626	NIVELADOR	25X80	QA3002	NIQ	NELSON	208	2
021627	NIVELADOR	30X25	QA3002	NIQ	NELSON	320-40	4

CÓDIGO	NOMBRE	MEDIDA	LARGO	MARCA	MASTER
021833	TUBO REDONDO	12MM 1/2	L3MT	NELSON	20-25
021834	TUBO REDONDO	25MM 1	L3MT	NELSON	20-10
021835	TUBO REDONDO	19MM 3/4	L3MT	NELSON	20-10

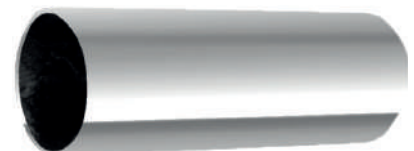

021832

**TUBO OVALADO**

LARGO	3 M
REF.	DLT002-T1002
MASTER	20
MARCA	NELSON

023900

**Piston Push**

REF.	T9019
COLOR	ACERO
MASTER	500-100
MARCA	NELSON

023906

**PISTÓN PUSH REFORZADO**

REF.	T9020
MARCA	NELSON
CARTÓN	Crt600
COLOR	NIQ

023901

**PISTÓN DOBLE PUSH REFORZADO**

REF.	T9021
MARCA	NELSON
CARTÓN	Crt240
COLOR	NIQ

021805

**SOPORTE TUBO REDONDO**

TIPO	CENTRAL
REF.	T2026
MASTER	180-30
MARCA	NELSON

021801

**SOPORTE TUBO OVALADO**

TIPO	CENTRAL
REF.	K1604/T2035
MEDIDA	15X25MM
MASTER	300 - 4
MARCA	NELSON

021820

**SOPORTE TUBO OVALADO LATERAL**

REF.	2036
MARCA	NELSON
CARTÓN	68/64

021806

**SOPORTE TUBO REDONDO**

TIPO	LATERAL
REF.	T2032
MARCA	NELSON

021802

**SOPORTE TUBO REDONDO**

REF.	2033
MARCA	NELSON
CARTÓN	250-2



CÓD.	NOMBRE	PRESIÓN	REF.	COLOR	MARCA	MASTER
023903	PISTON GAS	80N	YD-701/WA2002/T9002	NIQ	NELSON	100-25
023904	PISTON GAS	120N	YD-701	NIQ	NELSON	100-30
023905	PISTON GAS	100N	WA2002/T9002	NIQ	NELSON	100-25

MAGNÉTICO CAJÓN	
REF.	17004
MARCA	NELSON
CARTÓN	1800-50
MED	45X15X12MM



021208



021211



021210

BRAZO RADIAL MUEBLE	
REF.	T4a006
MARCA	NELSON
CARTÓN	Crt100
MED	90-180°

HERRAJE CONECTOR MUEBLE	
REF.	T4a009
MARCA	NELSON
CARTÓN	Crt100
MED	156x55mm

DESLIZADOR MUEBLE	
REF.	T4a008
MARCA	NELSON
CARTÓN	100
MED	12CM



021200



021803



021804

HERRAJE UNIÓN MUEBLE	
REF.	T4a012
MARCA	NELSON
CARTÓN	Crt500
MEDIDA	97x45mm
COLOR	NIQ

SOPORTE TUBO	
TIPO	OVALADO LATERAL
REF.	T2034
MASTER	1000
MARCA	NELSON

SOPORTE TUBO	
TIPO	OVALADO LATERAL
REF.	LS1602
MASTER	2000
MARCA	NELSON



023606

TOPE PUERTA ACERO

MED.	50X23X38MM
COLOR.	SN
MASTER	200
CAJA	1



021824

SOPORTE VIDRIO AJUSTABLE

REF.	TI7008
MED.	Ajust 5-10mm
CARTÓN	2000



021722

UNION METALICA

REF.	4A011
MARCA	NELS
CARTÓN	500 - 50
MED	110X40MM

**TORNILLO NEGRO GRUESO PARA MADERA**

CÓDIGO	NOMBRE	MED.	CABEZA	MARCA	MASTER	CAJITA
022735	T NEGRO	6X5/8	GRUESO	NELSON	12500	100
022790	T NEGRO	6X1	GRUESO	NELSON	20800	17000
022728	T NEGRO	6X1	GRUESO	NELSON	4800	100
022721	T NEGRO	6X1-1/2	GRUESO	NELSON	4000	100
022727	T NEGRO	6X1-5/8	GRUESO	NELSON	6000/5000	500
022730	T NEGRO	6X2	GRUESO	NELSON	3000	100
022741	T NEGRO	7X1	GRUESO	NELSON	4800	100
022737	T NEGRO	7X1-1/2	GRUESO	NELSON	5000/4000	100
022740	T NEGRO	7X1-1/4	GRUESO	NELSON	9000	500
022746	T NEGRO	7X2	GRUESO	NELSON	3000	100
022744	T NEGRO	7X2-1/2	GRUESO	NELSON	6000/4000	500
022743	T NEGRO	7X2-1/2	GRUESO	NELSON	2000	100
022769	T NEGRO	8X5/8	GRUESO	NELSON	4800	100
022753	T NEGRO	8X1	GRUESO	NELSON	4800	100
022775	T NEGRO	8X1-1/4	GRUESO	NELSON	5000/4800	100
022794	T NEGRO	8X1-1/2	GRUESO	NELSON	4200	100
022759	T NEGRO	8X2	GRUESO	NELSON	3000	100
022756	T NEGRO	8X2-1/2	GRUESO	NELSON	4000	100
022766	T NEGRO	8X3	GRUESO	NELSON	1800	100
022763	T NEGRO	8X3/4	GRUESO	NELSON	9000	100
022757	T NEGRO	8X3-1/2		NELSON		100
022700	T NEGRO	10X1	GRUESO	NELSON	10000/12000	500
022701	T NEGRO	10X1-1/2	GRUESO	NELSON	3000	100
022707	T NEGRO	10X2	GRUESO	NELSON	1800	100
022704	T NEGRO	10X2-1/2	GRUESO	NELSON	3500	100
022762	T NEGRO	10X3	GRUESO	NELSON	1200	100
022709	T NEGRO	10X3-1/2		NELSON	400	100
022716	T NEGRO	12X3	GRUESO	NELSON	2500	500
022714	T NEGRO	12X3-1/2	GRUESO	NELSON	2000	400
022773	T NEGRO	12X4	GRUESO	NELSON	200	500
022777	T NEGRO	14x4	GRUESO	NELSON	1200	200



TORNILLO NEGRO GRUESO PARA MADERA

CÓDIGO	NOMBRE	MED.	CABEZA	MARCA	MASTER	CAJITA
022797	T NEGRO	8X1	GRUESO X KILO	NELSON	20 -APROX 545UND.	1KG
022798	T NEGRO	8X1-1/2	GRUESO X KILO	NELSON	20 -APROX 380UND.	1KG
022799	T NEGRO	8X2	GRUESO X KILO	NELSON	20 -APROX 300UND.	1KG
022814	T NEGRO	8X2-1/2	GRUESO X KILO	NELSON	20	KG
022815	T NEGRO	8X3	GRUESO X KILO	NELSON	20	KG
022819	T NEGRO	6x1	GRUESO X KILO	NELSON	20 -APROX 730UND.	KG
022968	T NEGRO	6X1 - 1/2	GRUESO X KILO	NELSON	20 -APROX 515 UND.	KG
023012	T NEGRO	6X2	GRUESO X KILO	NELSON	20 -APROX 400UND.	KG
022524	T NEGRO	7X1	GRUESO X KILO	NELSON	20- APROX 680UND.	KG
023039	T NEGRO	7X1 - 1/2	GRUESO X KILO	NELSON	20- APROX 460UND.	KG
022754	T NEGRO	7X2	GRUESO X KILO	NELSON	20 -APROX 3600UND.	KG



TORNILLO NEGRO FINO

CÓDIGO	NOMBRE	MED	TIPO	MARCA	MASTER	CAJITA
022781	T NEGRO R/FINA	6X1	R/FINA	NELSON	9000	100
022764	T NEGRO R/FINA	6X1 X KILO	R/FINA	NELSON	20	1KG
022782	T NEGRO R/FINA	6X1-1/2	R/FINA	NELSON	6000	200
022783	T NEGRO R/FINA	6X2	FINO	NELSON	4000	200
022813	T NEGRO R/FINA	8X1 X KILO	R/FINA	NELSON	20	1KG
023060	T NEGRO R/FINA	8X1-1/2	R/FINA	NELSON	6000	500
022729	T NEGRO R/FINA	8x1	R/FINA	NELSON	4800	100
022782	T NEGRO R/FINA	6x1-1/2	R/FINA	NELSON	6000	200
022783	T NEGRO R/FINA	6x2	R/FINA	NELSON	3200	200



TORNILLO NEGRO

CÓDIGO	NOMBRE	MED	TIPO	MARCA	MASTER	CAJITA
023063	T NEGRO BROCA	6X1/2	FINO	NELSON	12500	100
023064	T NEGRO BROCA	6X1/2	FINO	NELSON	18000	500
023065	T NEGRO BROCA	6X1	FINO	NELSON	7000	100
023066	T NEGRO BROCA	6X1	FINO	NELSON	6500	500
023062	T NEGRO BROCA	6X1-1/4	FINO	NELSON	6500	500
023061	T NEGRO BROCA	6X1-1/4	FINO	NELSON	7000	100

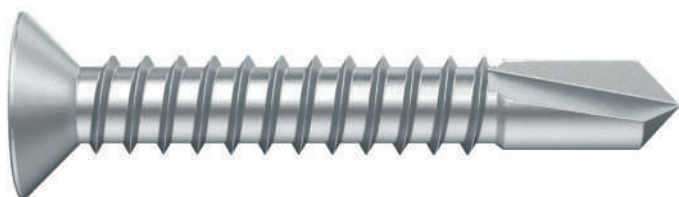

TORNILLO BROCA

CÓDIGO	NOMBRE	MED	CABEZA	REF.	COLOR	MARCA	MASTER	CAJITA
023001	T BROCA	6X1-1/2	C/AVEL	N.24-50	NIQ	NELSON	6000	200
023002	T BROCA	6X1-1/4	C/AVEL	N.24-50	NIQ	NELSON	6000	200
023003	T BROCA	6X1/2	C/AVEL	N.24-50	NIQ	NELSON	9000	200
023004	T BROCA	6X1	C/AVEL	DIN7504	NIQ	NELSON	9000	200
023005	T BROCA	6X3/4	C/AVEL	N.24-50	NIQ	NELSON	6000	200
023006	T BROCA	6X5/8	C/AVEL	N.24-50	NIQ	NELSON	6000	200
023010	T BROCA	8X1/2	C/AVEL	N.24-50	NIQ	NELSON	15000	100
023014	T BROCA	8X5/8	C/AVEL	N.24-50	NIQ	NELSON	18000	200
023018	T BROCA	8X1	C/AVEL	DIN7504	GALV	NELSON	13500	500
023019	T BROCA	8X1-1/2	C/AVEL	DIN7504	GALV	NELSON	9000	500
023022	T BROCA	8X3	C/AVEL	DIN7504	GALV	NELSON	3000	500
023025	T BROCA	8X2	C/AVEL	DIN7504	GALV	NELSON	4800	200
023068	T BROCA	8X3/4	C/AVEL	DIN7504	GALV	NELSON	9600	200
023069	T BROCA	8X5/8	C/AVEL	DIN7504	GALV	NELSON	9600	200
023028	T BROCA	8X1/2	C/AVEL		GALV	NELSON	6000	200
022780	T BROCA	8X1/2	C/AVEL		GALV	NELSON	5000	100

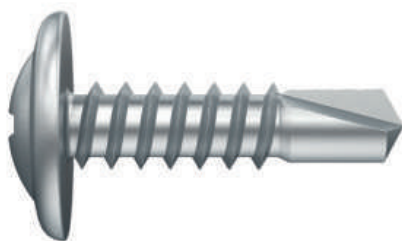

TORNILLO BROCA

CÓDIGO	NOMBRE	MED	CABEZA	COLOR	MARCA	MASTER	CAJITA
023031	T BROCA	6X1-1/2	C/SOMB	SN	NELSON	6000	200
023032	T BROCA	6X1-1/4	C/SOMB	SN	NELSON	6000	200
023034	T BROCA	6X1	C/SOMB	SN	NELSON	6000	200
023035	T BROCA	6X3/4	C/SOMB	SN	NELSON	6000	200
023036	T BROCA	6X5/8	C/SOMB	SN	NELSON	6000	200
023038	T BROCA	8X1-1/4	C/SOMB	NIQ	NELSON	4000	200
023042	T BROCA	8X2	C/SOMB	GALV	NELSON	2400/3200	200
023048	T BROCA	8X2-1/2	C/SOMB	GALV	NELSON	2000	200
023053	T BROCA	8X1	C/SOMB	GALV	NELSON		
023054	T BROCA	8X1-1/2	C/SOMB	GALV	NELSON	6000	200
022989	T BROCA	8X3/4	C/SOMB	GALV	NELSON		
023047	T BROCA	8X1/2	C/SOMB	GALV	NELSON	9000	200
023049	T BROCA	8X1	C/SOMB	GALV	NELSON	6000	200
023051	T BROCA	8X1/2	C/SOMB	GALV	NELSON		
023023	T BROCA	8X3/4	C/SOMB	GALV	NELSON	6000	200
023046	T BROCA	8X3/4	C/SOMB	GALV	NELSON		
023007	T BROCA	8X1-1/2	C/SOMB	GALV	NELSON	4200	100
023037	T BROCA	8X1-1/2	C/SOMB		NELSON		100



TORNILLO PARA MADERA Y ALUMINIO

CÓDIGO	NOMBRE	MED	PESO	CARTÓN	MARCA	COLOR
022807	T ZINC	8X1	KILO	CRT20-1KG 540UN APROX	NELSON	
022808	T ZINC	8X1-1/2	KILO	CRT20-CJ1KG 380UN APROX	NELSON	
022809	T ZINC	8X2	KILO	CRT20-1KG-290UN APROX	NELSON	
022736	T ZINC	7X1 - 1/2	KILO	CRT20	NELSON	
023045	T ZINC	7X2	KILO	CRT20	NELSON	
022806	T GYPSUM	8X2-1/2		CRT5000-500	NELSON	NIQUEL
022810	T DORADO	8X1	KILO	CRT20-CJ1KG-540UN APROX	NELSON	
022811	T DORADO	8X1-1/2	KILO	CRT20-CJ1KG-380 UN APROX	NELSON	
022812	T DORADO	8X2	KILO	CRT20-CJ1KG-290 UN APROX	NELSON	
022821	T DORADO	7X1	MILL	CRT5000	NELSON	DORADO
022820	T DORADO	7X1	MILL	CRT5000	NELSON	DORADO
022703	T DORADO	7X2	MILL	CRT5000	NELSON	DORADO

TORNILLO HEXAGONAL GALVANIZADO

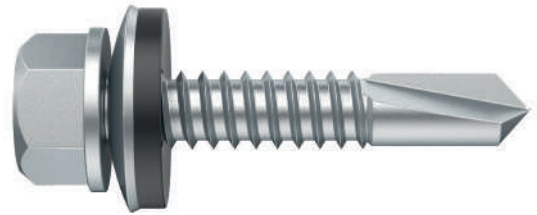

CÓDIGO	NOMBRE	MED"	CABEZA	COLOR	MARCA	MASTER	CAJITA
022502	T CAUCHO	10X1-1/2	HEXAG	GALV	NELSON	3000/6000	500
022505	T CAUCHO	10X1	HEXAG	GALV	NELSON	4000/6000	500
022508	T CAUCHO	10X2	HEXAG	GALV	NELSON	2000/2400	200
022510	T CAUCHO	10X3/4	HEXAG	GALV	NELSON	5000/6000	500
022522	T CAUCHO	10X1-1/4	HEXAG	GALV	NELSON	2000	500
022511	T CAUCHO	12x1-1/2	HEXAG	GALV	NELSON	2600/2400	200
022514	T CAUCHO	12x1	HEXAG	GALV	NELSON	4000/6000	500
022518	T CAUCHO	12x2-1/2	HEXAG	GALV	NELSON	1500	250
022516	T CAUCHO	12x2-1/2	HEXAG	GALV	NELSON	1500/3000	500
022519	T CAUCHO	12x3	HEXAG	GALV	NELSON	1500	500
022529	T CAUCHO	12x3	HEXAG	GALV	NELSON	2600	200
022531	T CAUCHO	12x4	HEXAG	GALV	NELSON	1200	100
022504	T CAUCHO	10x2-1/2	HEXAG	GALV	NELSON	10000	500
022509	T CAUCHO	10x3	HEXAG	GALV	NELSON	1000	500

TORNILLO PATO

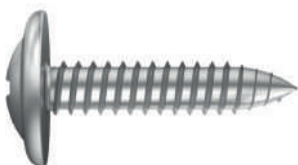

CÓDIGO	NOMBRE	MEDIDA	CABEZA	COLOR	MARCA	MASTER
022986	T PATO	8x1/2	C/SOMB	GALV	NELSON	15000
022987	T PATO	8x3/4	C/SOMB	GALV	NELSON	12000
022988	T PATO	8X1	C/SOMB	GALV	NELSON	4800
023043	T PATO	8X1/2	C/SOMB	GALV	NELSON	12000
023013	T PATO	8X1/2	C/SOMB	GALV	NELSON	13500
022932	T PATO	8X1	C/SOMB	GALV	NELSON	8000
022765	T PATO	8X3/4	C/SOMB	GALV	NELSON	8000

TORNILLO CONFIRMAT

MEDIDA	5X50
REF.	
COLOR	GALV
MASTER	4000/5000/6000
MARCA	NELSON

022803

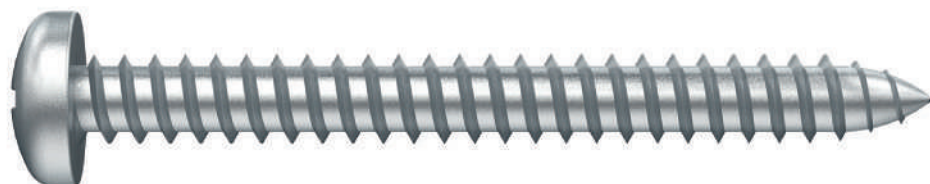
**TORNILLO
PATO**

CÓDIGO	NOMBRE	MED	CABEZA	REF.	COLOR	MARCA	MASTER	CAJITA
022961	T PATO	4X1/2	C/PAN	DIN7981	GALV	NELSON	30000	200
022962	T PATO	4X1/2	C/PAN		NIQ	NELSON	200	
022963	T PATO	4X3/8	C/PAN	DIN7981	GALV	NELSON	40000	200
022964	T PATO	4X3/8	C/PAN		NIQ	NELSON	25000	200
022969	T PATO	6X3/4	C/PAN		NIQ	NELSON	7200	200
022970	T PATO	6X5/8	C/PAN	DIN7981	GALV	NELSON	20000	200
022971	T PATO	6X5/8	C/PAN		NIQ	NELSON	14000	200
022972	T PATO	8X1-1/2	C/PAN	DIN7981	GALV	NELSON	4800	200
022974	T PATO	8X1-1/4	C/PAN		NIQ	NELSON	7200	200
022976	T PATO	8X1/2	C/PAN		NIQ	NELSON	14000	200
022979	T PATO	8X2	C/PAN	DIN7981	GALV	NELSON	3800	200
022982	T PATO	8X3/4	C/PAN		NIQ	NELSON	7200	200
022983	T PATO	8X3	C/PAN	DIN7981	GALV	NELSON	2800	200
022985	T PATO	8X5/8	C/PAN		NIQ	NELSON	7200	200
022990	T PATO	8X1	C/PAN		NIQ	NELSON	12000	200
022967	T PATO	6X1/2	C/PAN		NIQ	NELSON	14000	200
022975	T PATO	6X1/2	C/PAN		NIQ	NELSON	15000-100	
022993	T PATO	8X5/8	C/PAM		NIQ	NELSON	15000-500	



TORNILLO TIRAFONDO GALVANIZADO

CÓDIGO	NOMBRE	MED"	REF.	COLOR	MARCA	MASTER	CAJITA
022612	TIRAFONDO	1/4X1-1/2	DIN571	GALV	NELSON	2000	500
022602	TIRAFONDO	1/4X2-1/2	DIN571	GALV	NELSON	1500	500
022607	TIRAFONDO	1/4X3	DIN571	GALV	NELSON	1000	500
022609	TIRAFONDO	1/4X4		GALV	NELSON	1000	500
022610	TIRAFONDO	1/4X5	DIN571	GALV	NELSON	600	200
022611	TIRAFONDO	1/4X2		GALV	NELSON	2000	500
022605	TIRAFONDO	1/4X3-1/2		GALV	NELSON	1000	500

TORNILLO TIRADERA

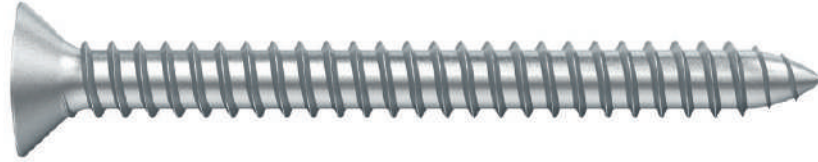

CÓDIGO	NOMBRE	MEDIDA	TIPO	MASTER	MARCA
022802	TIRADERA	4X50	CORTANTE	7200	NELSON



CÓDIGO	NOMBRE	MED	CABEZA	REF.	COLOR	MARCA	MASTER	CAJITA
022900	T PATO	10X1	C/AVEL	D7982	NIQ	NELSON	9000	500
022902	T PATO	10X2	C/AVEL	DIN7982	GALV	NELSON	2800	200
022903	T PATO	10X3-1/2	C/AVEL	DIN7982	GALV	NELSON	2000	200
022905	T PATO	12X2-1/2	C/AVEL	D7982	NIQ	NELSON	2000/1600	200
022906	T PATO	12X2	C/AVEL	D7982	NIQ	NELSON	3000	500
022908	T PATO	12X3	C/AVEL	D7982	NIQ	NELSON	2000	500
022910	T PATO	12X4	C/AVEL	D7982	NIQ	NELSON	2000/3000	500
022917	T PATO	6X1-1/4	C/AVEL	D7982	NIQ	NELSON	7200	200
022919	T PATO	6X1/2	C/AVEL	D7982	NIQ	NELSON	18000	200
022923	T PATO	6X3/4	C/AVEL	D7982	NIQ	NELSON	19200	200
022926	T PATO	6X5/8	C/AVEL	D7982	NIQ	NELSON	12000/135000	500
022929	T PATO	8X1-1/4	C/AVEL	D7982	NIQ	NELSON	50000	100
022931	T PATO	8X1-1/4	C/AVEL	D7982	GALV	NELSON	7200	200
022933	T PATO	8X1	C/AVEL	D7982	NIQ	NELSON	7000	100
022943	T PATO	8X2-1/2	C/AVEL	D7982	NIQ	NELSON	4000/2000	200
022946	T PATO	10X1-1/2	C/AVEL	D7982	NIQ	NELSON	6000	500
022947	T PATO	10X2	C/AVEL	D7982	NIQ	NELSON	4000	500
022948	T PATO	10X2-1/2	C/AVEL	D7982	NIQ	NELSON	3000	500
022903	T PATO	10X3	C/AVEL	D7982	GALV	NELSON	2000	200
022941	T PATO	8X5/8	C/AVEL		NIQ	NELSON	16000	200
022751	T PATO	6X5/8	C/AVEL		NIQ	NELSON		200
022527	T PATO	12X3	C/AVEL		NIQ	NELSON	16000	200
022918	T PATO	6X1/2	C/AVEL		NIQ	NELSON	15000	100
022922	T PATO	6X5/8	C/AVEL		NIQ	NELSON	8000/15000	100
022928	T PATO	8X1 1/2	C/AVEL		NIQ	NELSON	4500	100

T. HEXAGONAL CAUCHO PUNTA FINA PARA MADERA



CÓDIGO	NOMBRE	MED	CARTÓN	MARCA	COLOR
022530	T. HEXAGONA . FINA	12X1-1/2"	CRT 500	NELSON	GALV.
022517	T. HEXAGONA . FINA	12X2	CRT 500	NELSON	GALV.
022532	T. HEXAGONA . FINA	12X2 -1/2"	CRT 500	NELSON	GALC.
022613	T. HEXAGONA . FINA	10X3/4	CRT 500	NELSON	GALC.
022503	T. HEXAGONA . FINA	10X1	CRT 500	NELSON	GALC.
022525	T. HEXAGONA . FINA	10X1-1/2	CRT 500	NELSON	GALC.
022608	T. HEXAGONA . FINA	10X2	CRT 500	NELSON	GALC.

TIRADERA TUBULAR LIVIANA



CÓDIGO	NOMBRE	LARGO	COLOR	REF.	MARCA	MASTER
021342	TIRADERA TUB LIVIANA	10x64	S/N	ACERO	NELSON	600-60
021343	TIRADERA TUB LIVIANA	10x76	S/N	ACERO	NELSON	600-60
021344	TIRADERA TUB LIVIANA	10x96	S/N	ACERO	NELSON	500-50
021345	TIRADERA TUB LIVIANA	10x128	S/N	ACERO	NELSON	400-40
021379	TIRADERA TUB LIVIANA	12x64	S/N	ACERO	NELSON	600-60
021378	TIRADERA TUB LIVIANA	12x76	S/N	ACERO	NELSON	500-50
021324	TIRADERA TUB LIVIANA	12x96	S/N	ACERO	NELSON	500-50
021321	TIRADERA TUB LIVIANA	12x128	S/N	ACERO	NELSON	400-50/40
021325	TIRADERA TUB LIVIANA	12x160	S/N	ACERO	NELSON	400-40
021326	TIRADERA TUB LIVIANA	12x192	S/N	ACERO	NELSON	400-40
021369	TIRADERA TUB LIVIANA	12x320	S/N	ACERO	NELSON	300-30
021064	TIRADERA TUB LIVIANA	12x96	NEGRO	ACERO	NELSON	
021096	TIRADERA TUB LIVIANA	12x128	NEGRO	ACERO	NELSON	
021160	TIRADERA TUB LIVIANA	12x160	NEGRO	ACERO	NELSON	

TIRADERA TUBULAR PESADA



CÓDIGO	NOMBRE	LARGO	REF.	COLOR	MARCA	MASTER
021339	TIRADERA TUB	10x64	HD-F098-JS7671	SN	NELSON	250/150-25
021340	TIRADERA TUB	10x76	HD-F098-JS7671	SN	NELSON	150-20/25
021341	TIRADERA TUB	10x96	HD-F098-JS7671	SN	NELSON	240/150-30/25
021331	TIRADERA TUB	10x128	HD-F098-JS7671	SN	NELSON	160
021332	TIRADERA TUB	10x160	HD-F098-JS7671	SN	NELSON	160-20/150-30
021333	TIRADERA TUB	10x192	HD-F098-JS7671	SN	NELSON	125-25
021337	TIRADERA TUB	10x320	HD-F098-JS7671	SN	NELSON	100-25
021372	TIRADERA TUB	12x64	HD-F098-JS7671	SN	NELSON	200
021376	TIRADERA TUB	12x76	HD-F098-JS7671	SN	NELSON	150/120-20
021377	TIRADERA TUB	12x96	HD-F098-JS7671	SN	NELSON	160/120-20
021361	TIRADERA TUB	12x128	HD-F098-JS7671	SN	NELSON	160-20
021362	TIRADERA TUB	12x160	HD-F098-JS7671	SN	NELSON	120-20
021301	TIRADERA TUB	12x192	HD-F098-JS7671	SN	NELSON	100
021367	TIRADERA TUB	12x320	HD-F098-JS7671	SN	NELSON	80
021304	TIRADERA TUB	12x640	HD-F098-JS7671	SN	NELSON	100
021373	TIRADERA TUB	12x672	HD-F098-JS7671	SN	NELSON	100
021374	TIRADERA TUB	12x704	HD-F098	SN	NELSON	100
021375	TIRADERA TUB	12x736	HD-F098	SN	NELSON	30
021305	TIRADERA TUB	12x768	HD-F098	SN	NELSON	40-20

CÓDIGO	NOMBRE	MEDIDA	REF.	COLOR	MARCA	MASTER
021390	TIRADERA TUB	10X64	JS7671	BP	NELSON	150



CÓDIGO	NOMBRE	MEDIDA	REF.	COLOR	MARCA	MASTER
021380	TIRADERA TUB	10X96	JS7671	AB	NELSON	240-30
021381	TIRADERA TUB	12X96	JS7671	AB	NELSON	150-25

CÓDIGO	NOMBRE	LARGO	REF.	COLOR	MARCA	CARTÓN
021131	TIRADERA	96MM	TIR5198	NIQ	NELSON	250-25
021132	TIRADERA	128MM	TIR5198	NIQ	NELSON	250-25



CÓDIGO	NOMBRE	LARGO	REF.	COLOR	MARCA	CARTÓN
021201	TIRADERA	128MM	HDF027	NIQ	NELSON	200-10
021202	TIRADERA	96MM	HDF027	NIQ	NELSON	200-10

CÓDIGO	NOMBRE	LARGO	REF.	COLOR	MARCA	CARTÓN
021136	TIRADERA	96MM	TIR7672	NIQ	NELSON	250-50
021137	TIRADERA	128MM	TIR7672	NIQ	NELSON	250-50



021125



021144



021145

TIRADERA CUADRADA

LARGO	64MM
REF.	HDFB081
REF.	ACERO
MASTER	200-50
MARCA	NELSON

TIRADERA

MEDIDA	400X19MM
TIPO	DOBLE DUCHA
REF.	RM9503
COLOR	BSN
MARCA	NELSON

TIRADERA

MEDIDA	400X19MM
TIPO	SIMPLE DUCHA
REF.	RM9503
COLOR	BSN
MARCA	NELSON

021037
BSN

CÓD.	NOMBRE	MEDIDA	REF.	COLOR	MASTER	CAJA
021104	TIRADERA CUADRADA	96MM	HDF078	NIQ	500	50
021127	TIRADERA CUADRADA	128MM	HDFB081	NIQ	200	50

BOTÓN

MEDIDA	30 MM
FORMA	REDONDO
REF.	1060
COLOR	BSN
MASTER	60 UNI
MARCA	NELSON

NOMBRE	FORMA	REF.	COLOR	MASTER	MARCA
BOTÓN	REDONDO	1053	AB/BSN	50	NELSON



021029 AB

BSN 021030



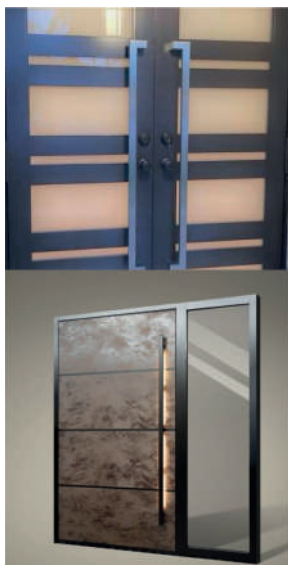

ACERO 304

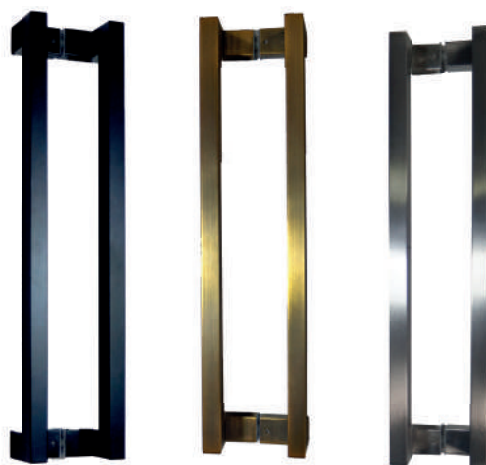
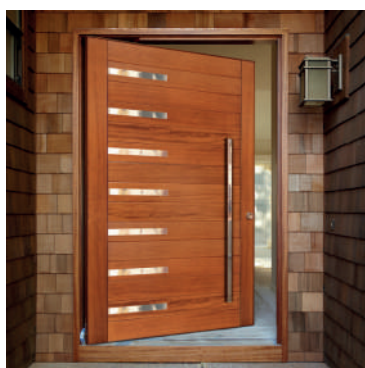
CÓDIGO	NOMBRE	LARGO	PERFORACIÓN	COLOR	REF.	MASTER	CAJA
021420	TIRADERA EXTERIOR C	25x38x1200mm	1160mm	SN	ACERO	12	2
021421	TIRADERA EXTERIOR C	25x38x1200mm	1160mm	NEGRO MATE	ACERO	12	2
021422	TIRADERA EXTERIOR C	25x38x1200mm	1160mm	AB	ACERO	12	2
021424	TIRADERA EXTERIOR C	25x38x600mm	560mm	SN	ACERO	15	2
021423	TIRADERA EXTERIOR C	25x38x600mm	560mm	NEGRO MATE	ACERO	15	2
021425	TIRADERA EXTERIOR C	25x38x600mm	560mm	AB	ACERO	15	2
021426	TIRADERA EXTERIOR C	25x38x450mm	410mm	SN	ACERO	20	2
021427	TIRADERA EXTERIOR C	25x38x450mm	410mm	NEGRO MATE	ACERO	20	2
021428	TIRADERA EXTERIOR C	25x38x450mm	410mm	AB	ACERO	20	2

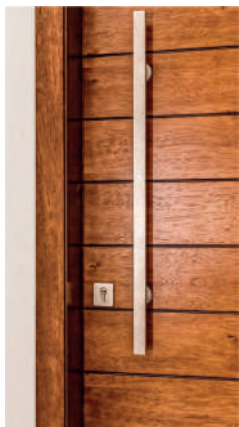

ACERO 304

CÓDIGO	NOMBRE	LARGO	PERFORACIÓN	COLOR	REF.	MASTER	CAJA
021387	Tiradera Exterior C Doble	25x38x1200mm	1160mm	SN	ACERO	6	2par
021388	Tiradera Exterior C Doble	25x38x1200mm	1160mm	NEGRO MATE	ACERO	6	2par
021389	Tiradera Exterior C Doble	25x38x1200mm	1160mm	AB	ACERO	6	2par
021395	Tiradera Exterior C Doble	25x38x600mm	560mm	SN	ACERO	10	2par
021396	Tiradera Exterior C Doble	25x38x600mm	560mm	NEGRO MATE	ACERO	10	2par
021394	Tiradera Exterior C Doble	25x38x600mm	560mm	AB	ACERO		2par
021397	Tiradera Exterior C Doble	25x38x450mm	410mm	SN	ACERO	10	2par
021398	Tiradera Exterior C Doble	25x38x450mm	410mm	NEGRO MATE	ACERO	10	2par
021399	Tiradera Exterior C Doble	25x38x450mm	410mm	AB	ACERO	10	2par

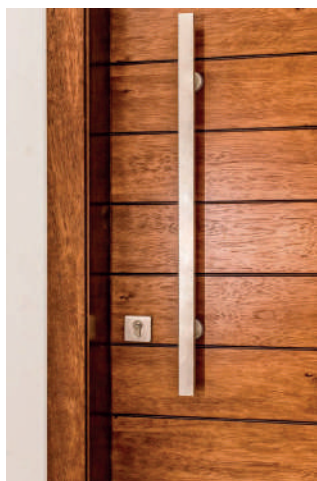

ACERO 304

CÓDIGO	NOMBRE	LARGO	PERFORACIÓN	COLOR	REF.	MASTER	CAJA
021351	Tiradera Cuadrad Ext doble	40x1200mm	900mm	SN	ACERO	6	1par
021352	Tiradera Cuadrad Ext doble	40x1200mm	900mm	Negro Mate	ACERO	6	1par
021353	Tiradera Cuadrad Ext doble	40x1200mm	900mm	AB	ACERO	6	1par
021354	Tiradera Cuadrad Ext doble	40x600mm	400mm	SN	ACERO	15	1par
021355	Tiradera Cuadrad Ext doble	40x600mm	400mm	Negro Mate	ACERO	15	1par
021356	Tiradera Cuadrad Ext doble	40x600mm	400mm	AB	ACERO	15	1par
021357	Tiradera Cuadrad Ext doble	40x450mm	300mm	SN	ACERO	20	1par
021358	Tiradera Cuadrad Ext doble	40x450mm	300mm	Negro Mate	ACERO	20	1par
021359	Tiradera Cuadrad Ext doble	40x450mm	300mm	AB	ACERO	20	1par



ACERO 304

CÓDIGO	NOMBRE	LARGO	PERFORACIÓN	COLOR	REF.	MASTER	CAJA
021432	Tiradera Acero Ext Cuadrada	40x1200mm	900mm	SN	ACERO	12	2
021433	Tiradera Acero Ext Cuadrada	40x1200mm	900mm	Negro Mate	ACERO	12	2
021434	Tiradera Acero Ext Cuadrada	40x1200mm	900mm	AB	ACERO	12	2
021360	Tiradera Acero Ext Cuadrada	40x600mm	400mm	SN	ACERO	30	2
021382	Tiradera Acero Ext Cuadrada	40x600mm	400mm	Negro Mate	ACERO	30	2
021383	Tiradera Acero Ext Cuadrada	40x600mm	400mm	AB	ACERO	15	2
021384	Tiradera Acero Ext Cuadrada	40x450mm	300mm	SN	ACERO		2
021385	Tiradera Acero Ext Cuadrada	40x450mm	300mm	Negro Mate	ACERO		2
021386	Tiradera Acero Ext Cuadrada	40x450mm	300mm	AB	ACERO	20	2



ACERO 304

CÓDIGO	NOMBRE	LARGO	PERFORACIÓN	COLOR	REF.	MASTER	CAJA
021300	Tiradera Tub Exterior Doble	32x1200mm	900mm	SN	ACERO	6	1par
021306	Tiradera Tub Exterior Doble	32x1200mm	900mm	NEGRO MATE	ACERO	6	1par
021307	Tiradera Tub Exterior Doble	32x1200mm	900mm	ACERO	ACERO	6	1par
021308	Tiradera Tub Exterior Doble	32x1200mm	900mm	AB	ACERO	5	1par
021309	Tiradera Tub Exterior Doble	32x600mm	400mm	SN	ACERO	15	1par
021310	Tiradera Tub Exterior Doble	32x600mm	400mm	NEGRO MATE	ACERO	15	1par
021311	Tiradera Tub Exterior Doble	32x600mm	400mm	ACERO	ACERO	15	1par
021312	Tiradera Tub Exterior Doble	32x600mm	400mm	AB	ACERO	15	1par
021313	Tiradera Tub Exterior Doble	32x450mm	300mm	SN	ACERO	20	1par
021314	Tiradera Tub Exterior Doble	32x450mm	300mm	NEGRO MATE	ACERO	20	1par
021315	Tiradera Tub Exterior Doble	32x450mm	300mm	ACERO	ACERO	20	1par
021316	Tiradera Tub Exterior Doble	32x450mm	300mm	AB	ACERO	20	1par



ACERO 304

CÓDIGO	NOMBRE	LARGO	COLOR	REF.	MASTER	CAJA
021317	Tiradera Tub Exterior	32x1200mm	SN	ACERO	12	2
021318	Tiradera Tub Exterior	32x1200mm	NEGRO MATE	ACERO	12	2
021319	Tiradera Tub Exterior	32x1200mm	ACERO	ACERO	12	2
021328	Tiradera Tub Exterior	32x1200mm	AB	ACERO	10	2
021429	Tiradera Tub Exterior	32x600mm	SN	ACERO	30	2
021329	Tiradera Tub Exterior	32x600mm	NEGRO MATE	ACERO	30	2
021330	Tiradera Tub Exterior	32x600mm	ACERO	ACERO	30	2
021346	Tiradera Tub Exterior	32x600mm	AB	ACERO	15	2
021347	Tiradera Tub Exterior	32x450mm	SN	ACERO		2
021348	Tiradera Tub Exterior	32x450mm	NEGRO MATE	ACERO		2
021349	Tiradera Tub Exterior	32x450mm	ACERO	ACERO		2
021350	Tiradera Tub Exterior	32x450mm	AB	ACERO	20	2



CÓDIGO	NOMBRE	LARGO	COLOR	REF.	MASTER	CAJA
021430	Tiradera Comercial Empujar	80x300mm	SN	ACERO	100	2
021431	Tiradera Comercial Halar	80x300mm	SN	ACERO	100	2



021012

BOTÓN T	
MEDIDA	10MM /12MM
REF.	JS7675-HDF098
COLOR	BSN
MASTER	500
CAJITA	50
MARCA	NELSON



021018

BOTÓN	
MEDIDA	38 MM
REF.	BOT51324
COLOR	NIQ
MASTER	250
CAJITA	25
MARCA	NELSON



021019

BOTÓN	
MEDIDA	32 MM
REF.	BOT5212
COLOR	NIQ
MASTER	400
CAJITA	50
MARCA	NELSON



021020

BOTÓN	
MEDIDA	30 MM
REF.	BOT5276K
COLOR	NIQ
MASTER	400
CAJITA	50
MARCA	NELSON

021038
CPSNAB
021023

BOTÓN	
MEDIDA	29 MM
REF.	1010
COLOR	AB / CPSN
MASTER	1000
CAJITA	100
MARCA	NELSON

BSN
021008AB
021014

BOTÓN	
MEDIDA	40 MM
FORMA	REDONDO
REF.	1008
COLOR	AB / BSN
MASTER	50 UNI
MARCA	NELSON



021027

AB

BSN
021026

BOTÓN	
MEDIDA	29 MM
FORMA	REDONDO
REF.	1027F
COLOR	AB / BSN
MASTER	50 UNI
MARCA	NELSON



AB

021021

BSN
021015

BOTÓN	
MEDIDA	38 MM
FORMA	CUADRADO CURVO
REF.	1009
COLOR	AB / BSN
MASTER	50 UNI
MARCA	NELSON

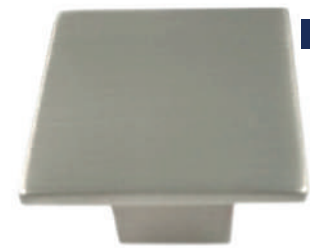

021016

BOTÓN CUADRADO	
MEDIDA	30 MM
REF.	BOT5220
COLOR	NIQ
MASTER	400
CAJITA	40
MARCA	NELSON



CÓDIGO	NOMBRE	MEDIDA	REF.	COLOR	CARTÓN	MARCA
021039	BOTÓN RECTANGULAR	60X12MM	T17043	DORADO	PAQ100	NELSON
021041	BOTÓN RECTANGULAR	60X12MM	T17043	ROSE GOLDEN	PAQ100	NELSON
021040	BOTÓN RECTANGULAR	60X12MM	T17043	NEGRO	PAQ100	NELSON

ACERO

021043



BOTÓN PERDIDO ACERO INOX	
MEDIDA	58MM
FORMA	REDONDO
REF.	ACERO
COLOR	SN
MASTER	100/1
MARCA	NELSON

ACERO

021042



BOTÓN BAÑO ACERO INOX	
MEDIDA	30 MM
FORMA	REDONDO
REF.	ACERO
COLOR	SN
MASTER	100/1
MARCA	NELSON

023200



JUEGO DE ANCLAS MEDIA LUNA M8	
REF.	M8
MARCA	NELSON
MASTER	CRT 5PCS



020003

Regulador de GAS Industrial

REF.	C70
PRESIÓN	12Kg/H
MASTER	50
MARCA	NELSON



020001

REGULADOR DE GAS DOMÉSTICO V80

REF.	2kg/H
PRESIÓN	50
CAJITA	1
MARCA	NELSON



023201

GRAPA LUNA DE MIEL

REF.	C1028B/D
COLOR	NÍQUEL
MASTER	40-4 UNI
MARCA	NELSON



023202

GRAPA LUNA DE MIEL

TIPO	
REF.	C1028B/D
COLOR	DORADO
MASTER	40-4 UNI
MARCA	NELSON

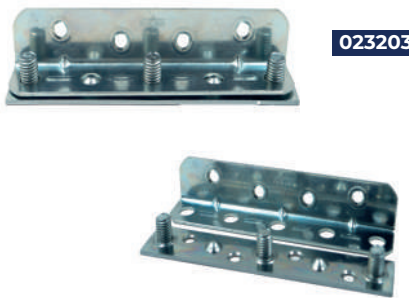

023203

GRAPA LUNA DE MIEL GRANDE

MED.	156mmx28mm
COLOR	NÍQUEL
MASTER	30-4
MARCA	NELSON



020212

BISAGRA

MEDIDA	3X1-1/2
REF.	MT1027
COLOR	AC
MARCA	NELSON
MASTER	CRT

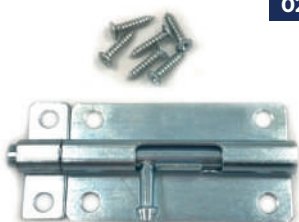

021412

PICAPORTE

MEDIDA	4" 1.2MM
REF.	MT1026
COLOR	SN
MARCA	NELSON
MASTER	CRT



023104

GARRUCHA TRANSP 2

REF.	14007
CARTON	100
MARCA	NELSON



023803

MASCARILLA TELA

TIPO	
REF.	
COLOR	NEGRA
MASTER	1500-50
MARCA	NELSON



CÓDIGO	NOMBRE	ALTO	REF.	MARCA	CARTON
023105	GARRUCHA REDONDA	P50	XH0019	NELSON	200
023106	GARRUCHA REDONDA	P38	XH0019	NELSON	200

CÓDIGO	NOMBRE	ALTO	REF.	MARCA	FUNDA
023101	GARRUCHA	1-1/2	XH0008	NELSON	400-40



CÓDIGO	NOMBRE	TIPO	MED.	REF.	CARTON
023100	GARRUCHA NARANJA	C/Freno	1,5 pg	T14019	200
023107	GARRUCHA NARANJA	S/Freno	1,5 pg	T14019	250
023108	GARRUCHA NARANJA	C/Freno	2 pg	T14019	120
023109	GARRUCHA NARANJA	S/Freno	2 pg	T14019	150



TAPAS PARA TORNILLO MINI FIX

CÓDIGO	NOMBRE	MEDIDA.	MARCA	FUNDA
023401	TAPA BLANCA	18X4.2MM	NELSON	2500
023402	TAPA CAFE	18X4.2MM	NELSON	2500
023403	TAPA NEGRA	18X4.2MM	NELSON	2500

CINTA DECORATIVA MUEBLE



CÓDIGO	MEDIDA	COLOR	REF.
223456	5mmxR15m	Dorado	Zd-pv02
225457	5mmmxR15m	Niquel	Zd-pv02
223458	20mmxR15m	Dorado	Zd-pv02
223459	20mmxR15m	Niquel	Zd-pv02
223460	50mmxR15m	Dorado	Zd-pv02
223461	50mmxR15m	Niquel	Zd-pv02
223462	100mmxR15m	Dorado	Zd-pv02
223463	100mmxR15m	Niquel	Zd-pv02

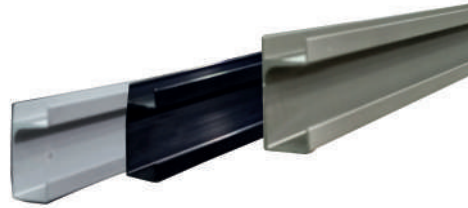
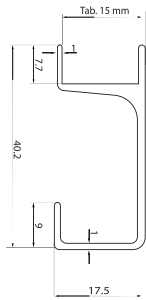

CÓDIGO	NOMBRE	MEDIDA	COLOR	REF.
021212	PERFIL ALUMINIO	15x40x3000mm	PLATEADO	L4xa
021213	PERFIL ALUMINIO	15x40x3000mm	NEGRO	L4xa
021214	PERFIL ALUMINIO	15x40x3000mm	BRONCE	L4xa

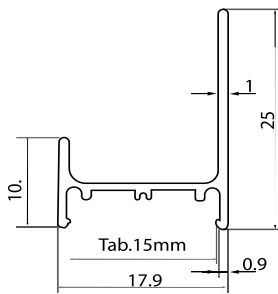

CÓDIGO	NOMBRE	MEDIDA	COLOR
021215	PERFIL ALUMINIO	15x25x3000mm	PLATEADO
021216	PERFIL ALUMINIO	15x25x3000mm	NEGRO
021217	PERFIL ALUMINIO	15x25x3000mm	BRONCE

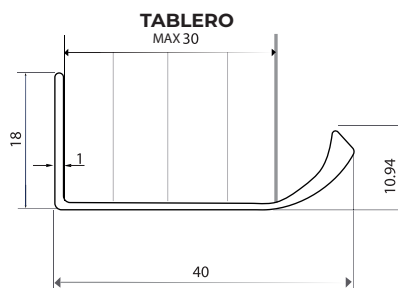

CÓDIGO	NOMBRE	MEDIDA	COLOR
021220	PERFIL ALUMINIO	15/Max30x18x3000mm	PLATEADO
021219	PERFIL ALUMINIO	15/Max30x18x3000mm	NEGRO
021218	PERFIL ALUMINIO	15/Max30x18x3000mm	BRONCE



CÓDIGO	NOMBRE	MED	COLOR	MASTER	CAJA
023406	BANDA PUERTA SILICON	35MM X R5MT	TRASP	30	1ROLLO
023408	BANDA PUERTA SILICON	60MM X R5MT	TRASP	30	1ROLLO
023407	BANDA PUERTA SILICON	110MM X R5MT	TRASP	30	1ROLLO
023410	BANDA PUERTA SILICON	35MM X 5MT	NEGRO	30	1ROLLO



CÓDIGO	NOMBRE	MED	COLOR	MASTER	CAJA
023413	TIRA SELLANTE VENTANA	9MM X 10MTS	CAFÉ	50	1ROLLO
023414	TIRA SELLANTE VENTANA	9MM X 10MTS	NEGRO	540	1ROLLO

MAX DE PUERTA 45 MM



CÓDIGO	NOMBRE	MED	COLOR	MASTER	CAJA
023405	BANDA PUERTA ESPUMA	LAR. 910X ESP. 38MM	NEGRO	100	1
023409	BANDA PUERTA ESPUMA	LAR. 910X ESP. 38MM	CAFÉ	100	1

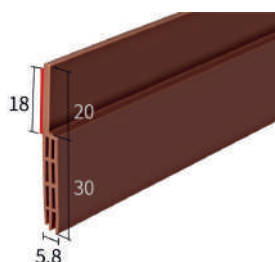

CÓDIGO	NOMBRE	MED	COLOR	MRCA	CAJA
023404	BANDA SOLIDA PUERTA PLAST	1020X50MM	CAFÉ	NELSON	1



NELSON

HERRAJES / MAQUINARIA



CÓDIGO	NOMBRE	MOTOR	VOLTAJE	MEDIDA	REF.	MARCA
630006	ESCUADRADORA	4HP	220 V Trif.	280CM	MJ6128T+INSISOR1HP	NELSON



ESCUADRADORA	
MOTOR	4 HP
VOLTAJE	220V
PULGADA	12 PG
TOTAL CORTE LONG.	160 CM
REF.	MJ6116TYB + INSISOR1HP
TOTAL CORTE TRANS.	1250 MM
CORTE	A 0 GRADOS 80MM
CORTE	A 45 GRADOS 55 MM
SALIDA DE EXTRACCIÓN	4" (100 MM)
MOTOR INCISOR	1 HP (750W)
INCISOR	120X20 MM
RPM	4000 - 6000
MARCA	NELSON

TOTAL DE CORTE TRANS.	1250 MM
CORTE	A 0 GRADOS 80 MM
CORTE	A 45 GRADOS 55 MM
SALIDA DE EXTRACCIÓN	4" (100MM)
MOTOR INCISOR	1 HP (750W)
INCISOR	120x20 MM
RPM	4000-6000
EJE	30MM



SIERRA MESA	
MOTOR	3 HP
VOLTAJE	220V
PULGADA	10PG
REF.	SB250DS
CORTE	A 0 GRADOS 75MM
CORTE	A 45 GRADOS 60 MM
SALIDA DE EXTRACCIÓN	4" (100MM)
INCISOR	NO
EJE	30MM
MARCA	NELSON



SIERRA MESA	
MOTOR	3 HP
VOLTAJE	110/220V
REF.	SB250G

**630002****SIERRA CINTA**

MOTOR	1 HP (750W)
VOLTAJE	110V
PULGADA	14 PG
REF.	HBS350
ANCHO DE CORTE	330 MM
ALTURA DE CORTE	160 MM
SALIDA DE EXTRACCIÓN	4" (100MM)
RPM	1700
SIERRA	2400 MM
MARCA	NELSON

**630003****SIERRA CINTA**

MOTOR	3 HP
VOLTAJE	220V
PULGADA	18 PG
REF.	HBS450
ANCHO DE CORTE	440 MM
ALTURA DE CORTE	320 MM
SALIDA DE EXTRACCIÓN	4" (100MM)
RPM	1700
SIERRA	3430 MM
MARCA	NELSON



**Para:
Lijadora Banda
630004**

CÓDIGO	NOMBRE	MEDIDA	GRANO	MARCA
562045	LIJA BANDA	6X1.25	40 99PG.	FANDELI
562046	LIJA BANDA	6X1.25	60 99PG.	FANDELI
562047	LIJA BANDA	6X1.25	80 99PG.	FANDELI
562048	LIJA BANDA	6X1.25	100 99PG.	FANDELI
562049	LIJA BANDA	6X1.25	120 99PG.	FANDELI



630011

COLECTOR POLVO

MOTOR	3 HP
VOLTAJE	220V
CAUDAL	1760 CFM
Ø COLECTOR	500 MM
REF.	FM 300S



630012

COLECTOR POLVO

MOTOR	1 HP
VOLTAJE	110 V
CAUDAL	600 CFM
Ø COLECTOR	370 MM
REF.	FM230



630013

COLECTOR POLVO

MOTOR	2 HP
VOLTAJE	110V / 220V
CAUDAL	1790 CFM
Ø COLECTOR	500 MM
REF.	FM 300



630039

COLECTOR POLVO

MOTOR	5 HP
VOLTAJE	380V
CAUDAL	2500 CFM
Ø COLECTOR	500 MM
REF.	FM 305



630008

COLECTOR POLVO

MOTOR	7 HP
VOLTAJE	380V
CAUDAL	2996 CFM
Ø COLECTOR	MM
REF.	FM 470



630052

MANGUERA ANILLADA

PULGADAS	4"
METROS	6MTS
REF.	COLECTOR DCA-3-4



CÓDIGO	NOMBRE	COLECTOR	TIPO	REF.
630016	BOLSA	1HP	FILTRAR POLVO	FM230-25
630015	BOLSA	1HP	RECOGER POLVO	FM230-24
630017	BOLSA	2HP	RECOGER POLVO	FM300-35



630009

PUERTA DE PASO COLECTOR

REF.	COLECTOR DCA-5-4
------	------------------

630042

**MOTOR PARA COLECTOR**

MOTOR	7 HP
VOLTAJE	220V - TRIF
REF.	FM470-17

630042

**MOTOR PARA COLECTOR**

MOTOR	5,5 HP
VOLTAJE	220V - TRIF
REF.	FM300S-5-17



NELSON

HERRAJES / MAQUINARIA

W.P.: Presión de Trabajo (Work Pressure)
 B.P.: Presión de Ruptura (Burst Pressure)

MAGUERA AIRE

Ideal para conexiones de aire, de trabajo pesado.
 Presión de trabajo W.P.: 16 bar./240 psi.



CÓDIGO	NOMBRE	ESPESOR	METRAJE	USO	COLOR	MARCA
023730	MAGUERA AIRE	6MM	10MTS	COMPRESOR	AMARILLA	NELSON
023731	MAGUERA AIRE	6MM	15MTS	COMPRESOR	AMARILLA	NELSON

HEAVY-DUTY MAGUERA AIRE

Manguera de aire de alta fluidez, es un tubo hueco flexible diseñado para transportar fluidos de un lugar a otro. Ideal para las conexiones de sistemas de aire.

W.P.: Presión de Trabajo (Work Pressure)
 B.P.: Presión de Ruptura (Burst Pressure)

CÓD.	NOMBRE	ESPESOR	ROLLO	COLOR	PROCEDENCIA	MARCA	PRESIÓN
023751	MAGUERA DE AIRE	8MM-5/16	10MTS	AZUL	KOREA	NELSON	600-2400psi
023752	MAGUERA DE AIRE	8MM-5/16	15MTS	AZUL	KOREA	NELSON	600-2400psi



TRABAJO MEDIO AIRE - AZUL

Ideal para las conexiones de sistemas de aire, gas de trabajo medio.
 Presión de trabajo W.P./ B.P.: 300-1200psi

CÓDIGO	NOMBRE	MEDIDA	PRESIÓN	COLOR	ROLLO	MARCA
023710	MAGUERA AIRE	8MM	300-1200psi	AZUL	R100MTS	NELSON

MAGUERA GAS

Ideal para las conexiones de gas doméstico. Presión de trabajo: W.P./B.P.: 300 - 900 psi

CÓD.	NOMBRE	MEDIDA	TIPO	PRESIÓN	COLOR	ROLLO	MARCA
023721	MAGUERA GAS	8MM	INDUSTRIAL	300-1200psi	AMARILLO	R100	NELSON
023722	MAGUERA GAS	8MM	DOMESTICO	300-900PSI	AMARILLO	R100	NELSON
023723	MAGUERA GAS	8MM	INDUSTRIAL	300-1200PSI	AMARILLO	R50	NELSON



MAGUERA MULTIPROPOSITO

Es una manguera que soporta ácidos, aire, agua, gas, químicos, gasolina, pesticidas, aceites fríos y la mayoría de solventes, excepto los que disuelven poliuretano. Conexiones de aire- gas- químicos livianos.

CÓDI.	NOMBRE	ESPESOR	ROLLO	MARCA	PRESIÓN
023740	MAGUERA MULTIPROPOSITO	6.5MM-1/4	R100MTRS	NELSON	300-900psi
023742	MAGUERA MULTIPROPOSITO	13MM-1/2	R100MTRS	NELSON	300-900psi
023747	MAGUERA MULTIPROPOSITO	8MM-5/16	R100MTRS	NELSON	300-900 psi



MAGUERA DE AGUA INDUSTRIAL

CÓDIGO	NOMBRE	ESPESOR	ROLLO	COLOR	MARCA	PRESIÓN
023706	MAGUERA AGUA INDUSTRIAL	13 mm	10MTS	TRANSP	NELSON	120-360psi
023707	MAGUERA AGUA INDUSTRIAL	13 mm	20MTS	TRANSP	NELSON	120-360psi



W.P.: Presión de Trabajo (Work Pressure)
 B.P.: Presión de Ruptura (Burst Pressure)

HEAVY-DUTY AGUA - NYLON

Es una manguera para agua de trabajo pesado.
 100% flexible y resistente.



CÓDIGO	NOMBRE	MEDIDA	TIPO	ROLLO	MARCA	PRESIÓN
023701	MANGUERA AGUA	13MM-1/2	NYLON TRANSP	R90MTRS	NELSON	120-360psi
023702	MANGUERA AGUA	19MM-3/4	NYLON TRANSP	R90MTRS	NELSON	90-270psi
023703	MANGUERA AGUA	25MM-1	NYLON TRANSP	R50MTRS	NELSON	90-270psi
023705	MANGUERA AGUA	50MM-2	NYLON TRANSP	R50MTRS	NELSON	45-180 psi

MANGUERA NIVEL

Manguera de agua ideal para trabajo de construcción y hogares

CÓD.	NOMBRE	ESPESOR INT-EXT	COLOR	ROLLO	MARCA
023770	MANGUERA NIVEL	8X10	TRANSP	R90MTS	NELSON



MANGUERA JARDIN

CÓDIGO	NOMBRE	COLOR	ROLLO	MARCA
212002	MANGUERA JARDIN	BICOLOR	R100MTRS	NELSON



020001

REGULADOR DE GAS DOMÉSTICO

MEDIDA	
REF.	
PRESIÓN	
MASTER	2 Kg/h
CAJITA	1
MARCA	NELSON



020003

REGULADOR DE GAS INDUSTRIAL

MEDIDA	
REF.	C 70
PRESIÓN	12kg/h
MASTER	
CAJITA	1
MARCA	NELSON



 **FeRRO** 



ESPECIFICACIÓN

Tiene un deslizamiento silencioso y uniforme gracias al juego de rulimanes internos. Permite la extensión completa del cajón hacia fuera del mueble.

CÓDIGO	NOMBRE	MED"	ANCHO	TIPO	COLOR	MARCA	MASTER	FUNDA
022206	RIEL	10	35MM	EXT	ZINC	FERRO	20	2
022314	RIEL	12	35MM	EXT	ZINC	FERRO	25	2
021902	RIEL	16	35MM	EXT	ZINC	FERRO	25	2
022404	RIEL	18	35MM	EXT	ZINC	FERRO	25	2
022042	RIEL	20	35MM	EXT	ZINC	FERRO	25	2
022101	RIEL	14	35MM	EXT	ZINC	FERRO	25	
022109	RIEL	22	35MM	EXT	ZINC	FERRO	25	2
021335	RIEL	10	42MM	EXT	ZINC	FERRO	20	2
022022	RIEL	12	42MM	EXT	ZINC	FERRO	15	2
022023	RIEL	14	42MM	EXT	ZINC	FERRO	15	2
021901	RIEL	16	42MM	EXT	ZINC	FERRO	15	2
022044	RIEL	18	42MM	EXT	ZINC	FERRO	15	2
022144	RIEL	20	42MM	EXT	ZINC	FERRO	15	2

ESPECIFICACIÓN

Riel Oculta Soft

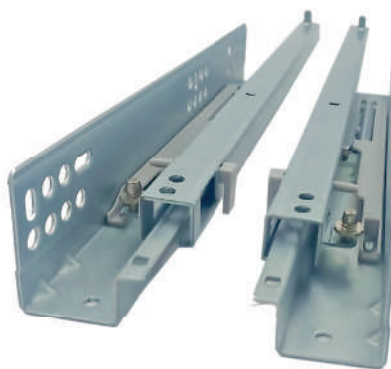

CÓDIGO	NOMBRE	PULGADAS	REF.	COLOR	MARCA	FUNDA
021303	RIEL OCULTA SOFT	14	T5009	ZINC	FERRO	Par
021831	RIEL OCULTA SOFT	16	T5009	ZINC	FERRO	Par
023302	RIEL OCULTA SOFT	18	T5009	ZINC	FERRO	Par
021366	RIEL OCULTA SOFT	20	T5009	ZINC	FERRO	Par

020213

**BISAGRA NORMAL RECTA**

CAZOLETA	35MM
REF.	LH261A
CARTÓN	100PRS
MARCA	FERRO

020804

**BISAGRA SEMICODO**

CAZOLETA	35MM
REF.	LH261B
CARTÓN	100PRS
MARCA	FERRO

020501

**BISAGRA SEMICODO**

CAZOLETA	-
REF.	1003C
CARTÓN	100PRS
MARCA	FERRO

020401

**BISAGRA SEMICODO**

CAZOLETA	35MM
REF.	T8002B
CARTÓN	100PRS
MARCA	FERRO

020810

**BISAGRA SEMICODO**

CAZOLETA	35MM
REF.	T8002-A
CARTÓN	100PRS
MARCA	FERRO

020624

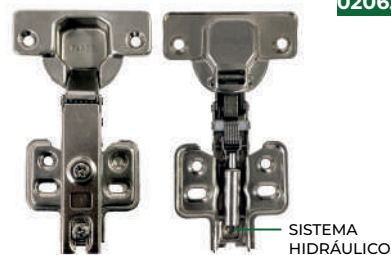
**BISAGRA HIDRÁULICA RECTA**

CAZOLETA	-
REF.	1003C
CARTÓN	100PRS
MARCA	FERRO

020800

**(105°)****BISAGRA MINI SEMICODO**

CAZOLETA	26MM
REF.	T8002-B
CARTÓN	100PRS
MARCA	FERRO

020626

**BISAGRA HIDRAULICA SEMICODO**

CAZOLETA	-
REF.	T8008B
CARTÓN	100PRS
MARCA	FERRO



CÓDIGO	NOMBRE	MEDIDA	REF.	MARCA
021450	TIRADERA TUB LIVIANA	12x64	RM6925	FERRO
021451	TIRADERA TUB LIVIANA	12x76	RM6925	FERRO
021452	TIRADERA TUB LIVIANA	12x96	RM6925	FERRO
021453	TIRADERA TUB LIVIANA	12x128	RM6925	FERRO
021454	TIRADERA TUB LIVIANA	12x160	RM6925	FERRO
021455	TIRADERA TUB LIVIANA	12x320	RM6925	FERRO



HOMEY®

502

220148

25°C

Temperatura
Máximo**ADHESIVO INSTANTANEO**

CONTENIDO	20G
MARCA	HOMEY

Adhesivo fuerte de secado rápido y transparente

- Uso: cerámica, cuero, madera, vidrio, plásticos, acrílico, etc
- Alta velocidad de secado (10sg)
- Incoloro y antiamarilleo

502

220230

25°C

Temperatura
Máximo**ADHESIVO INSTANTANEO**

CONTENIDO	30G
MARCA	HOMEY

Adhesivo fuerte de secado rápido y transparente

- Uso: cerámica, cuero, madera, vidrio, plásticos, acrílico, etc
- Alta velocidad de secado (10sg)
- Incoloro y antiamarilleo

590

220234

25°C

Temperatura
Máximo**ADHESIVO DE MONTAJE**

CONTENIDO	280ML
MARCA	HOMEY

Adhesivo premium a base de agua, apto para montaje de todo tipo de material

- Uso: Baldosas, marcos de puertas, MDF, madera, barrederas, cerámicas
- Adhesivo pintable
- Una vez seco es resistente a la humedad

577

220147

25°C

Temperatura
Máximo**ADHESIVO CLAVO LIQUIDO**

CONTENIDO	300ML
MARCA	HOMEY

Adhesivo de alta resistencia y unión formulado para fines de construcción

- Aislamiento acústico y tableros
- Resistencia al agua, rápido curado y agarre
- Revestimientos de pared PVC o WPC, madera, cerámica, mármol, piedra, etc

L322

220146

25°C

Temperatura
Máximo**ADHESIVO CLAVO LIQUIDO**

CONTENIDO	300ML
MARCA	HOMEY

Adhesivo multiusos con gran poder de sujeción ideal para pegar espejos

- Uso: cerámica, mampostería, caucho, vidrio, porcelanas, plásticos etc
- Resistente y duradero
- Excepcional para la construcción

P25

220236

25°C

Temperatura
Máximo**SELLADOR PARABRISAS**

CONTENIDO	310ML - NEGRO
MARCA	HOMEY

Sellador de poliuretano, usado para la línea de fabricación de automóviles

- Usado para la unión y sellado estructural de carrocerías de autos
- Instalación de vidrios laterales en autos
- Alta resistencia, viscosidad y curado rápido

P35

220235

25°C

Temperatura
Máximo**SELLADOR CONSTRUCCIÓN**

CONTENIDO	310ML - NEGRO
MARCA	HOMEY

Sellador de poliuretano que cura la humedad a temperatura ambiente

- Sella juntas de conductos de tuberías, piso/ escaleras, metal y madera
- Resistente a altas / bajas temperaturas
- Alta flexibilidad y pintable

1000

220238

25°C

Temperatura
Máximo**SELLADOR HIBRIDO**

CONTENIDO	300ML - BLANCO
MARCA	HOMEY

Sellador de poliuretano, usado en la industria de la construcción y automóviles

- Fuerte unión elástica en construcciones
- Instalación de vidrios laterales en autos
- Resistente al moho, interperie, rayos UV y puede ser pintado inmediatamente

3000

BLANCO
220232NEGRO
220233GRIS
220237

25°C

Temperatura
Máximo**SELLADOR HIBRIDO**

CONTENIDO	300ML
MARCA	HOMEY

Sellador para construcción y aplicarse en humedo, seco y dentro del agua

- Estabilidad al moho, incoloro y resist a la interperie y rayos UV
- Temperatura de aplicación 5°C y 35°C
- Luego del curado resiste -40°C y 90°C

660

BLANCO
221240NEGRO
221189TRANSP
221241

25°C

Temperatura
Máximo**SILICONA ACÉTICA**

CONTENIDO	280ML
MARCA	HOMEY

Sellador de vidrio hipoalergénico, no tiene látex, toxina, no es poroso y resiste al moho

- Sellado de vidrio, cerámica, porcelana, lugares como baño y cocina
- Excelente resistencia a la intemperie, luz ultravioleta, vibración

966

TRANSP
221242

25°C

Temperatura
Máximo**SILICONA NEUTRA**

CONTENIDO	300ML
MARCA	HOMEY

Silicona de curado neutro, versátil y de grado arquitectónico

- Paneles de fachada, revestimientos y superficies vidrio, aluminio, acero y vinilo
- Para azulejos, ladrillo, mármol y granito
- Resistente a la intemperie

H600

ROJO
221243

25°C

Temperatura
Máximo**SILICONA ALTA TEMPERATURA**

CONTENIDO	90G
MARCA	HOMEY

Silicona de alta calidad que soporta altas temperaturas hasta +315°C

- Sella juntas de conductos de tuberías, piso/escaleras, metal y madera
- Excelente propiedad de adhesión
- Resiste al envejecimiento, agua, aceite, vibraciones

680

TRANSP
221188

25°C

Temperatura
Máximo**SILICONA PREMIUM**

CONTENIDO	300ML
MARCA	HOMEY

Sellador de silicona de curado acetoxi con excelente propiedad de unión

- Capacidad de impermeabilidad y resistencia a los rayos UV
- Sellado de vidrio, porcelana, cerámica, vidriada, y algunos sustratos no porosos

30

25°C

Temperatura
Máximo750ML
228109500ML
228113300ML
228114**ESPUMA DE POLIURETANO**

CONTENIDO	-
MARCA	HOMEY

Espuma de Poliuretano usado para rellenar y sellar

- Estructura celular cerrada, resistente a la absorción de agua, más rígida y estable
- Alta tasa de expansión y curado rápido
- Fácil aplicación



A-B

25°C

Temperatura
Máximo**RESINA EPOXICA**

CONTENIDO	5KG
MARCA	HOMEY

Resina Epoxica es un adhesivo de resina epoxi transparente de dos componentes

- Utilizar para varias mesas de río y otras mesas de resina
- Baja viscosidad de mezcla, buen antiespumante y alta transparencia
- Resistencia al clima y al amarillamiento



220231

102



210222

PISTOLA PARA SELLADOR

COLOR	AZUL
MARCA	HOMEY

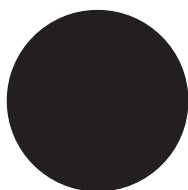

Negro Mate
228120

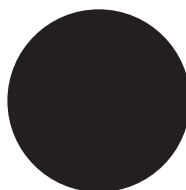

Negro Brillante
228121

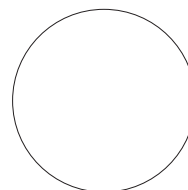

Blanco Mate
228122

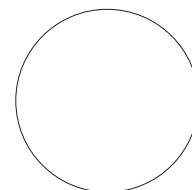

Blanco Brillante
228123

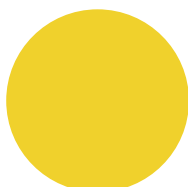

Amarillo 25
228126

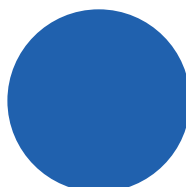

Azul
228128

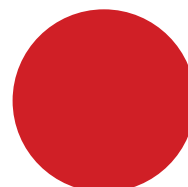

Rojo 131
228124

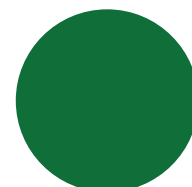

Verde Claro 37
228125

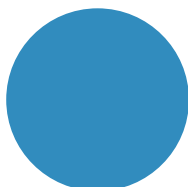

Celeste 15
228132



Naranja 672
228127

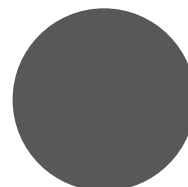

Gris 22
228130

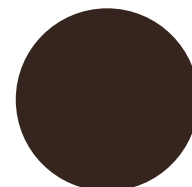

Café claro 135
228131

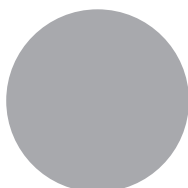

Plateado 36
228129

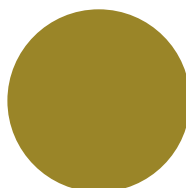

Dorado 18K
228133

SPRAY DE PINTAR

CONTENIDO	400ml
MARCA	HOMEY

Spray Paint adopta tecnología avanzada, además posee un excelente cobertura y adherencia. El secado es rápido y la película terminada tiene excelente dureza y brillo.

- Utilizado para decorar y reparar metal, madera, vidrio, cuero, cerámica, plásticos ABS, etc
- Amigable con el medio ambiente
- Gran variedad de colores



RONGPENG

CAFETERA R100

580156

Capacidad	120 cc
Boquilla	0.8 mm
Abanico	100 - 150 mm
Presión de aire	2.0 - 3.5 bar (50.75PSI)
Consumo de aire	2.0 - 3.5 cfm
Tipo	LVLTP
Trabajo	Industrial



CAFETERA R200S

580035

Capacidad	1000 cc
Boquilla	1.7 mm
Abanico	180 - 250 mm
Presión de aire	2.0 - 3.5 bar
Consumo de aire	3.0 - 3.9 cfm
Tipo	HVLP
Trabajo	Industrial



CAFETERA R500

580103

1.3 mm

580123

1.5 mm

580133

1.7 mm

Capacidad	600 cc
Boquilla	1.3 - 1.5 - 1.7 mm
Abanico	180 - 280 mm
Presión de aire	2.3 - 5.0 bar (72.5PSI)
Consumo de aire	3.0 - 3.9 cfm
Tipo	LVLTP
Trabajo	Industrial



REPUESTO Cafetera

588001

R200S

Boquilla	1.3 - 1.5 - 1.7 mm
Opcional	1.4 - 1.8 mm
1 Pieza	Tapa de aire
2 Pieza	Boquilla de flujo
3 Pieza	Set de aguja



VENTA POR SEPARADO

CAFETERA H827-E

580033

1.7 mm

580014

1.3 mm

580015

1.5 mm

Capacidad	600 cc
Boquilla	1.3 - 1.5 - 1.7 mm
Abanico	180 - 250 mm
Presión de aire	2.0 - 3.5 bar
Consumo de aire	4.2 - 7.1 cfm
Tipo	HVLP
Trabajo	Semi Industrial



CAFETERA 472

580104

Capacidad	750 cc
Boquilla	1.3 mm
Abanico	200 - 250 mm
Presión de aire	2.0 - 3.5 bar
Consumo de aire	3.5 - 6 cfm
Tipo	-
Trabajo	Semi Industrial



REPUESTO Cafetera

588031

R500

588002

H827

Boquilla	1.3 - 1.5 - 1.7 mm
Opcional	1.4 - 1.8 mm
1 Pieza	Tapa de aire
2 Pieza	Boquilla de flujo
3 Pieza	Set de aguja



VENTA POR SEPARADO

REPUESTO Cafetera

588101

472

Boquilla	1.3 mm
Opcional	-
1 Pieza	Tapa de aire
2 Pieza	Boquilla de flujo
3 Pieza	Set de aguja



VENTA POR SEPARADO

CAFETERA F75G

580021

1.5 mm

580022

1.3 mm

Capacidad	400 cc
Boquilla	1.3 - 1.5 mm
Abanico	180 - 250 mm
Presión de aire	3.0 - 4.0 bar
Consumo de aire	3.5 - 6.0 cfm
Tipo	HVLP
Trabajo	Semi Industrial



REPUESTO Cafetera

588043

F75

Boquilla	1.3 - 1.5 - 1.7 mm
Opcional	1.4 - 1.8 mm
1 Pieza	Tapa de aire
2 Pieza	Boquilla de flujo
3 Pieza	Set de aguja



VENTA POR SEPARADO

CAFETERA F75

584105

Capacidad	600 cc
Boquilla	1.3 mm
Abanico	180 - 250 mm
Presión de aire	3.0 - 4.0 bar
Consumo de aire	3.5 - 6.0 cfm
Tipo	HVLP
Trabajo	Semi Industria



CAFETERA PQ-2U

580245

Capacidad	1000 cc
Boquilla	1.8 mm
Abanico	180 - 230 mm
Presión de aire	3.0 - 4.0 bar (30PSI)
Consumo de aire	6.0 - 8.8 cfm
Tipo	Estandar
Trabajo	Semi Industrial



CLAVADORA F50B

583100

Color	Azul
Tipo Clavo	F1850
Presión	70 - 110 psi
Trabajo	Semí Industrial



REPUESTO Pistón Grapa

589000

Nombre	Pistón Grapadora
Ref.	F50B



VENTA POR SEPARADO

CLAVADORA F50RA

583101

Color	Plomo
Tipo Clavo	F1850
Presión	50 - 70 psi
Trabajo	Semí Industrial



REPUESTO Clavadora

580303

Nombre	Bumper Clavadora
Ref.	F50RA

589003

Nombre	Pistón Clavadora
Ref.	F50RA



CLAVADORA MIXTA GRAPADORA SF5040

585310

Color	Azul
Tipo Clavo	-
Presión	60 - 100 psi
Trabajo	Semi Industrial



REPUESTO Clavadora Grapadora

589211

Nombre	Bumper Clavadora
Ref.	SF5040

589008

Nombre	Pistón Clavadora
Ref.	SF5040



GRAPADORA 8016

584100

Color	Azul
Tipo Grapa	80
Presión	30 - 60 psi
Trabajo	Semi Industrial



REPUESTO Grapadora

580301

Nombre	Bumper Redondo
Ref.	8016

589005

Nombre	Pistón Grapadora
Ref.	8016



CLAVADORA HELICOIDAL MCN70

583210

Color	Plomo
Tipo Clavo	80
Presión	70 - 100 psi
Trabajo	Semi Industrial



REPUESTO Bumper Clavadora

580300

Nombre	Bumper Clavadora
Ref.	MCN70

VENTA POR SEPARADO



GRAPADORA RP8416

584200

Color	Azul
Tipo Grapa	84
Presión	70 - 110 psi
Trabajo	Semí Industrial



GRAPADORA 8016

584100

Color	Azul
Tipo Grapa	80
Presión	70 - 110 psi
Trabajo	Semí Industrial



GRAPADORA 9040C

580009

Color	Azul
Tipo Grapa	90
Presión	70 - 110 psi
Trabajo	Semi Industrial



GRAPADORA 7116A

581000

Color	Azul
Tipo Grapa	71
Presión	70 - 110 psi
Trabajo	Semi Industrial



GRAPADORA N851NP

584101

Color	Plomo
Tipo Grapa	155 - N8
Presión	70 - 100 psi
Trabajo	Semi Industrial



GRAPADORA R8016

584102

Color	Plomo
Tipo Grapa	80
Presión	72 - 87 psi
Trabajo	Industrial



CLAVADORA HELICOIDAL MCN55

584106

Color	Bronce
Tipo Clavo	1 1/2 - 2"
Presión	85 - 115 psi
Trabajo	Semi Industrial



CLAVADORA HELICOIDAL MCN80

584111

Color	Bronce
Tipo Clavo	1 1/2 - 3"
Presión	85 - 115 psi
Trabajo	Semi Industrial



PUNTILLADORA H625

582000

Color	Azul
Tipo Clavo	Puntilladora
Presión	60 - 100 psi
Trabajo	Semi Industrial



GRAPADORA V8016

589007

Color	Azul
Tipo Grapa	80
Presión	30 - 60 psi
Trabajo	Semi Industrial



KID TALADRO DE IMPACTO RP7488

584104

Revolución	3600 rpm
Motor	5 hp
Ent. aire	1/2"



CLAVADORA COMBO RP9202

584400

CLAVADORA F50B

Color	Azul
Calibre	18 (1.25 - 1.00 mm)
Clavo	15 - 50 (5/8" - 2")
Presión aire	30 - 60 psi (2.7 - 4.1 bar)
Trabajo	Semi Industrial

GRAPADORA 8016

Color	Azul
Corona	12.80 mm
Capacidad	120 grapas
Long. Grapa	1/4" - 5/8"
Presión aire	30 - 60 psi (2.7 - 4.1 bar)
Trabajo	Semi Industrial



LIJADORA ORBITAL RP27330

587000

Pulgadas	5"
Cartón	10
Trabajo	Semi Industrial



LIJADORA NEUMÁTICA RP7335

587001

Pulgadas	5"
Cartón	10
Trabajo	Semi Industrial



LIJADORA ORBITAL RP7324

587003

Pulgadas	-
Cartón	10
Trabajo	Semi Industrial



MINI PISTOLA AIRE RP8204

587206

Tipo	Aire
Cartón	100
Trabajo	Semi Industrial



PISTOLA DE AIRE RP8032-1

587207

Color	Azul
Cartón	100
Entrada	1/4"



MINI FILTRO RP8054

587403

Tipo	-
Cartón	100
Trabajo	-



VASO PLÁSTICO RP8702

587601

Capacidad	600 cc
Cartón	20
Tipo	Rosca interna



VASO ALUMINIO RP8704

587602

Capacidad	600 cc
Cartón	50
Tipo	Rosca externa



VASO PLÁSTICO RP8702

587604

Capacidad	1000 cc
Cartón	20
Tipo	Rosca Externa



PAD VELCRO RP8704

587808

Pulgadas	5"
Cartón	50
Revolución	10000 rpm



PISTOLA DE AIRE RP8032-2

587308

Medida	8 cm
Cartón	100
Entrada	1/4



REPUESTO GRAPADORA 7111A

580305

Ref.	7116A
Tipo	Bumper
Revolución	10000 rpm



BOMBA DE PINTAR R455

586001

Cartón	1
Tipo	Pintura arquitectónica
Manguera	15 Mts (Negra)



TANQUE RP8312

586003

Abanico	1.7 mm
Capacidad	Rebeldes
Trabajo	Semi Industrial
Entrada	70psi
Salida	Salida 20-30 psi



REPUESTO Pistón

580306

Nombre	Pistón Grapadora
Ref.	V8016

584109

Nombre	Bumper Grapadora
Ref.	V8016

VENTA POR SEPARADO



MANGUERA ESPIRAL AMARILLO

580400

15 mts

580401

7,5 mts

Medida	0,8 mm
Cartón	25/50



VASO PLÁSTICO RP8702

587604

Medida	1/2
Cartón	-
Tipo	Aceite



PISTOLA BATE PIEDRA RP8404/616

587012

Abanico	39 mm
Cartón	20
Color	Azul



REPUESTO Grapadora Helicoidal

584112

Nombre	Pistón grapadora
Ref.	MCN80

584113

Nombre	Bumper grapadora
Ref.	MCN80

VENTA POR SEPARADO



REPUESTO Puntilladora

589002

Nombre	Pistón grapadora
Ref.	H625

584114

Nombre	Bumper grapadora
Ref.	H625

VENTA POR SEPARADO



REPUESTO Clavadora

589001

Nombre	Pistón Grapadora
Ref.	CN70

584110

Nombre	Bumper Grapadora
Ref.	CN70

VENTA POR SEPARADO



REPUESTO Clavadora Helicoidal

584107

Nombre	Pistón Grapadora
Ref.	MCN55

584108

Nombre	Bumper Grapadora
Ref.	MCN55

VENTA POR SEPARADO



DESTORNILALDOR NEUMÁTICO RP7220

581004

Potencia	2Hp
Revolución	9000rpm
Manguera	3/8"
Torque	80 Ft-Lb
Perno	3 - 10 mm



KID TALADRO NEUMÁTICO RP7807

581201

Mandril	1/2
Referencia	RP7808
Revolución	7500 rpm
Trabajo	Semi Industrial
Presión	90 psi



KIT RECTIFICADORA RP7814

588011

Revolución	25000 rpm
Ent. de aire	1/4"
Manguera	3/8"
Presión	90 psi
Cons. de aire	4.5 cfm



TALADRO NEUMÁTICO RP7816

581003

Revolución	700 rpm
Ent. de aire	1/4"
Manguera	3/8"
Presión	90 psi
Cons. de aire	4 cfm



KIT RATCHET RP7806

588012

Revolución	160 rpm
Torque	68 N.m
Manguera	3/8"
Perno	1/2"
Cons. de aire	77 Lmin



TALADRO NEUMÁTICO RP7810

581002

Revolución	1800 rpm
Ent. de aire	1/4"
Manguera	3/8"
Presión	90 psi
Cons. de aire	3.7 cfm



CLAVADORA ELÉCTRICA BV5040

583104

Carga de batería	160 rpm
Voltaje	68 N.m
Disparo por min	3/8"
Capacidad	1/2"

Clavo	15 - 50 mm
Calibre clavillo	18
Grapa	16 - 40 mm
Calibre grapa	90



KIT HERRAMIENTAS RP7857

588010

BPM	4500 rpm
Ent. de aire	1/4"
Manguera	3/8"
Presión	6.3 bar
Cons. de aire	2.8 cfm
Vastago de cincel	10.2 mm



Revolución	7500 rpm
Ent. de aire	1/4"
Manguera	3/8"
Perno	M13
Cons. de aire	5 cfm
Torque	570 N.m



Revolución	160 rpm
Ent. de aire	1/4"
Manguera	3/8"
Presión	0.63 MPA
Cons. de aire	4 cfm
Torque	50 Ft-Lb



Revolución	25000 rpm
Ent. de aire	1/4"
Manguera	3/8"
Presión	0.63 MPA
Cons. de aire	3 cfm
Tapa amoladora	1/4"





SCHULZ

COMPRESORES

GENERALIDADES TÉCNICAS

Es una máquina que genera y almacena aire a presión dentro de un tanque de acero, mediante el acoplamiento de un motor eléctrico a una bomba neumática con el objeto de utilizar el aire comprimido con herramientas neumáticas para diversas tareas de la industria, el comercio, odontología y el hogar.

¿Cómo elegir un compresor de acuerdo a su necesidad?

PASOS A SEGUIR:

1. Debemos saber cuál es el consumo de aire, en volumen (CFM) de la máquina o herramienta.
2. El tiempo en horas de trabajo durante el cual vamos a utilizar la herramienta.
3. Dependiendo del tiempo de trabajo debemos incrementar la entrega de volumen de aire (CFM) del compresor de la siguiente manera:

EJEMPLO: LIJADORA NEUMÁTICA ROTOORBITAL, CONSUME 11CFM.

TIEMPO DE USO	HERRAMIENTA	%	COMPRESOR REQUERIDO
OCASIONAL	11 CFM	0	11 CFM
8 HORAS	11 CFM	50	17 CFM O MÁS
24 HORAS	11 CFM	75	20 CFM O MÁS

- VOLUMEN/CFM, viene del inglés; Cubic Feet Minute: Pies cúbicos por minuto.

- PRESIÓN/PSI, viene del inglés; Pound Square Inch: Libras por pulgada cuadrada.

TABLA DE REFERENCIA

HERRAMIENTAS	CONSUMO DE AIRE/CFM	PRESIÓN / PSI
PISTOLA THOMAS 527	2.7 CFM	40 PSI
PISTOLA DE GRAVEDAD HVLP	6-9 CFM	30-40 PSI
RATCHET 3/8	4.8 CFM	90 PSI
LLAVE DE IMPACTO 1/2	5.1 CFM	90 PSI
RECTIFICADOR 1/4	8 CFM	90 PSI
MINI ESMERILADORA	10 CFM	90 PSI
LIJADORA 7" V	12 CFM	90 PSI
TALADRO 3/8	9.2 CFM	90 PSI
CLAVADORA	0.8 CFM	90 PSI
SANBLASTER	9 CFM	90 PSI
PULVERIZADOR	4 CFM	60 PSI
ENGRASADORA	0.02 CFM	90 PSI
ENLLANTADORA	6 CFM	90 PSI
ENGRAPADORA	0.4 CFM	90 PSI
EQUIPOS LÁCTEOS	8 CFM	90 PSI
EMPACADORAS	8 CFM	90 PSI
SILLÓN DENTAL	2.5 CFM	90 PSI

CAMBIO DE ACEITE

- Primer cambio (5 horas de trabajo).
- Segundo Cambio (10 horas de trabajo).
- Posterior a este proceso los cambios de aceite se deben realizar cada 200 horas de trabajo.



300100

Linea
Bravo

COMPRESOR

MOTOR	3HP BRAVO
REVOLUCION	3600RPM
VOLTAJE	110/220
CAPACIDAD	200LTS
MODELO	BRAVO
CAUDAL	15CFM
PRESION	140PSI
MARCA	SCHULZ



300101

Linea
MAX

INDUSTRIAL

COMPRESOR

MOTOR	5HP MAX
REVOLUCION	3480RPM
FASE	TRIF
CAPACIDAD	220LTS
MODELO	MSV-20 VERTICAL
CAUDAL	20CFM
PRESION	175PSI
REF.:	(932.7284-0)
MARCA	SCHULZ



300102

Linea
MAX

INDUSTRIAL

COMPRESOR

MOTOR	5HP MAX
REVOLUCION	3480RPM
VOLTAJE	TRIF
CAPACIDAD	250LTS
MODELO	MSV-20 HORIZ
CAUDAL	20CFM
PRESION	175PSI
MARCA	SCHULZ



300104

INDUSTRIAL

COMPRESOR

MOTOR	7,5HP MAX
REVOLUCION	3840RPM
FASE	TRIF
CAPACIDAD	350LTS
MODELO	MSV-30
CAUDAL	30CFM
PRESION	175PSI
REF.:	(933.1304-0)
MARCA	SCHULZ



300105

Linea
MAX

INDUSTRIAL

COMPRESOR

MOTOR	10HP MAX
REVOLUCION	3480RPM
FASE	TRIF
CAPACIDAD	350LTS
MODELO	MSV-40
CAUDAL	40CFM
PRESION	175PSI
MARCA	SCHULZ



300106

INDUSTRIAL

COMPRESOR

MOTOR	15HP MAX
REVOLUCION	3480RPM
VOLTAJE	TRIF
CAPACIDAD	425LTS
MODELO	MSW-60
MARCA	SCHULZ
CAUDAL	60CFM
PRESION	175PSI



300111

Linea
Fort

INDUSTRIAL

COMPRESOR

MOTOR	10HP FORT
REVOLUCION	1720RPM
FACE	TRIF
CAPACIDAD	425LTS
MODELO	MSW-60
CAUDAL	400CFM
PRESION	175PSI
REF.:	(933-9311-0)
MARCA	SCHULZ



300112

Linea
Fort

INDUSTRIAL

COMPRESOR

MOTOR	15HP FORT
REVOLUCION	1740RPM
FASE	TRIF
CAPACIDAD	425LTS
MODELO	MSWV-60
CAUDAL	60CFM
PRESION	175PSI
REF.:	(934.3476-0)
MARCA	SCHULZ



300201

Linea
MAX

CABEZAL

MOTOR	5HP MAX
REVOLUCION	3600RPM
MODELO	MSV20
CAUDAL	20CFM
PRESION	175PSI
REF.:	(716.005745)
MARCA	SCHULZ



300203

Linea
MAX

CABEZAL

MOTOR	10HP MAX
REVOLUCION	3600RPM
FACE	TRIF
MODELO	MSW-40
CAUDAL	40CFM
PRESION	175PSI
MARCA	SCHULZ



300204

Linea
MAX

CABEZAL

MOTOR	15HP MAX
REVOLUCION	3600RPM
FASE	TRIF
MODELO	MSW-60
CAUDAL	60CFM
PRESION	175PSI
REF.:	(933.9388-0)
MARCA	SCHULZ



300221

Linea
Bravo

CABEZAL

MOTOR	3HP BRAVO
REVOLUCION	3600RPM
FASE	110/220
MODELO	OMAX CSL-15BR
CAUDAL	15CFM
PRESION	140PSI
MARCA	SCHULZ



300211

Linea
Fort

CABEZAL

MOTOR	10HP FORT
REVOLUCION	1700RPM
MODELO	MSW40
CAUDAL	40CFM
PRESION	17PSI
REF.:	(933.9303-0)
MARCA	SCHULZ



300505

FILTRO AIRE

MOTOR	15HP
REF.:	(007.0184)
USO	COMPRESOR TORNILLO
MARCA	SCHULZ



300504

Linea
Fort

FILTRO AIRE

MOTOR	40HP
REF.:	(007.0184-0)
USO	COMPRESOR DE TORNILLO
MARCA	SCHULZ



300502

FILTRO AIRE

MOTOR	5-15 HP
REF.:	(830-1257-0)
USO	COMPRESOR DE PISTÓN
MARCA	SCHULZ



300511

FILTRO AIRE

MOTOR	1-1.5 HP
REF.:	(830-1261-0)
USO	COMPRESOR DE PISTÓN
MARCA	SCHULZ



300611

FILTRO AIRE

MOTOR	15HP
TIPO	COALECENTE
REF.:	(007.0246-0)
USO	COMPRESOR TORNILLO
MARCA	SCHULZ



300601

FILTRO ACEITE

MOTOR	15HP
REF.:	(007-0177-0)
USO	COMPRESOR TORNILLO
MARCA	SCHULZ



300901

ELEMENTO SEPARADOR

MOTOR	15 HP
REF.:	(000.7.0233-0)
USO	AIRE-ACEITE
MARCA	SCHULZ



300520

FILTRO AIRE 5-15HP COMPLETO

MOTOR	5-15 HP
REF.:	(830.1264-0)
USO	COMPLETO
MARCA	SCHULZ



CÓDIGO	NOMBRE	MEDIDA	USO	MASTER	MARCA
309001	ACEITE	1/4	COMPRESOR PISTÓN	CRT12	SCHULZ
309002	ACEITE	GALÓN	COMPRESOR PISTÓN	CRT6	SCHULZ



301101



KIT REPARACION VALVULA

MOTOR	7 1/2 MAX
REF.:	
USO	
MARCA	SCHULZ



JITOOOL



521850

CLAVADORA

MED. CLAVO	F1850
REF.:	1850A
CANT.:	INDUSTRIAL
CARTÓN	10
MARCA	JITool

BOQUILLA CLAVADORA
1850A

525543

BUMPER CLAVADORA
F50 1850A19

525143

PISTON CLAVADORA
1850A 13A

523001

VALVULA
1850

525343

ORING CLAVADORA
1850A

526043

PUSHER SPRING
1850A

525243



521001

CLAVADORA CONCRETO

REF.:	CS15/50
CANT.:	INDUSTRIAL
CARTÓN	10
MARCA	JITool

BUMPER GRAAPDORA
CS15/50

525020

BUMPER GRAPADORA
CONCRETO CS15/50

525142

PISTON CLAVADORA
CONCRETO CS15/50

525002

PUSGER SPRING
C15/50

525202



522302

CLAVADORA

TIPO CLAVO	Helicoidal 1-1/4 a 2-1/2
REF.:	JCN65
CANT.:	INDUSTRIAL
MARCA	JITool

PISTON GRAPADORA
HELICODAL JCN65

528106

BUMPER CLAVADORA
JCN65

522025





522100

GRAPADORA

TIPO GRAPA	80 16
REF.:	JS16-80
CANT.:	INDUSTRIAL
CARTÓN	10
MARCA	JITool

BUMPER GRAPADORA
JS8016

525121

VALVULA
JS16-80

527015

BOQUILLA
JS16-80

525521

VALVULA GRAPADORA
JS16-80

527014

SELLO GRAPADORA
80 JS16-80

526621

PISTON GRAPADORA
JS16-80 14A

523102



522038

GRAPADORA

TIPO GRAPA	90 38
REF.:	JIS38
CANT.:	INDUSTRIAL
MARCA	JITool

PISTON GRAPADORA
JLS38

523105



520000

PUNTILLADORA

REF.:	630
CANT.:	INDUSTRIAL
CARTÓN	10
MARCA	JITool

BUMPER PUNTILLADORA
630-A-003

525160

VALVULA PUNTILLADORA
630

525360

PISTON PUNTILLADORA
630 14A

525006

VALVULA
630

525369

BOQUILLA
630

525560

PUSHER SPRING
630

525260



PISTON GRAPADORA
CT64R

525048



PISTON CLAVADORA HELICOIDAL
JN70C

525024



PISTON CLAVADORA HELICOIDAL
JN65S

525001



NARIZ CLAVADORA
JS65S

527004



VALVULA
JS65S

527013



ORING VALVE CLAVADORA
JS65S OUT

528502

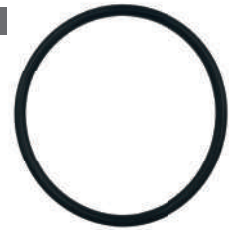

STOPPER PISTON CLAVADORA
JS65S

523003



HEAD VALVE CLAVADORA
JS65S

527012



CYLINDER CLAVADORA
JS65S

527005



BUMPER CLAVADORA
T64R

525148



VALVULA
JN65S

525331



BUMPER CLAVADORA HELICOIDAL
JN65S

525131



PUSHER SPRING
CT64R

525248



PUSHER SPRING
422

525290





BOSCH



214132

SIERRA PARA CALADORA

REF.	T244D
PAQUETE	5 UNIDADES



214133

SIERRA PARA CALADORA

REF.	T344D
PAQUETE	5 UNIDADES



214135

SIERRA PARA CALADORA

REF.	T111C
PAQUETE	5 UNIDADES



214136

SIERRA PARA CALADORA

REF.	T101B
PAQUETE	5 UNIDADES



214137

SIERRA PARA CALADORA

REF.	T101BR
PAQUETE	5 UNIDADES



214138

SIERRA PARA CALADORA

REF.	T144D
PAQUETE	5 UNIDADES



214077

REBAJADORA ENCHAPADO

REF.	GKF 550
POTENCIA	500W
REVOLUCIÓN	33.000 RPM
FRESA	6 mm



214074

LIJADORA DE PALMA

REF.	GSS 140
POTENCIA	220W
DIAMETRO	15
OCILACIÓN	14.000



214078

SIERRA CALADORA

REF.	GST 680
POTENCIA	500W
CORTE	68 mm
REVOLUCIÓN	800-3100RPM



214079

TALADRO PERCUTOR

REF.	GSB 550 RE
POTENCIA	500W
REVOLUCIÓN	0-31.000RPM
MANDRIL	1/2 / 13 mm



214080

TALADRO PERCUTOR

REF.	GSB 13 RE
POTENCIA	750W
REVOLUCIÓN	0-38.000RPM
MANDRIL	1/2 / 13 mm



214081

TALADRO PERCUTOR

REF.	GSB 16 RE
POTENCIA	850W
REVOLUCIÓN	0-35.000RPM
MANDRIL	1/2 / 13mm

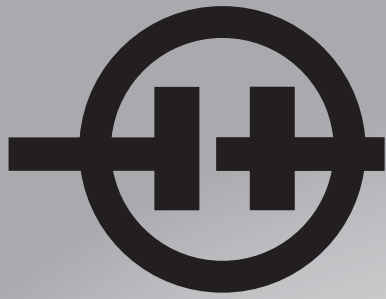

HERCULES

MOTORES ELÉCTRICOS



LINEA MONOFÁSICOS



Clase de Aislamiento F:
Soporta hasta 155° C



Rodamientos
de primera línea



Platino: Contacto doble.



Factor de servicio 1,15



Utiliza dos condensadores:
siendo un de Sólido y
un Permanente

LINEA BIFÁSICOS



Carcasa

inyectada en aluminio
de alta resistencia que hace
el producto más ligero.



Pies Removibles:
flexibilidad para cambiar
de forma constructiva.



Bobinados en
alambre de cobre



Clase de Aislamiento F:
Soporta hasta 155° C



Rodamientos
de primera línea



Platino: Contacto doble.



Factor de servicio 1,15

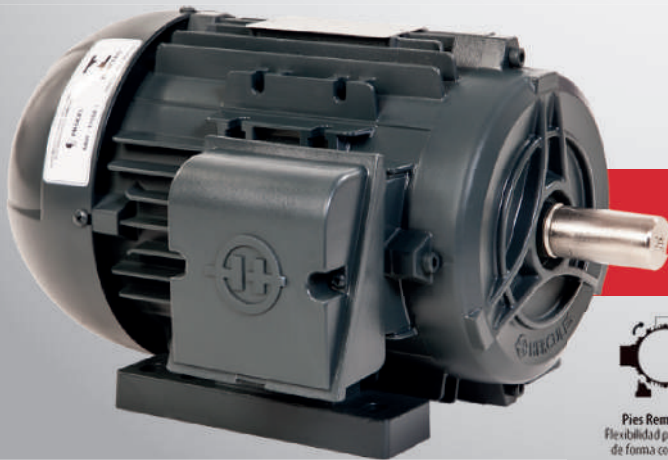

LINEA TRIFÁSICOS



Pies Removibles:
flexibilidad para cambiar
de forma constructiva.



Carcasa
inyectada en aluminio
de alta resistencia que hace
el producto más ligero.



Clase de Aislamiento F:
Soporta hasta 155° C



Caja de Conexión:
Permitiendo girar de 90° en 90°



Tapa deflectora
inyectada en polímero de
Alta Resistencia



Bobinados en
alambre de cobre



Factor de servicio 1,15



Rendimiento aprobado
pelo Inmetro



ALTO RENDIMIENTO





ABIERTO

MOTOR HERCULES MONOFASICO

Para uso general, desarrollando el máximo desempeño y rendimiento, transformados en confiabilidad y ahorro.

TENSION	120/220V
TRABAJO	INDUSTRIAL
CAPACITORES	ARRENQUE Y PERMANENTE
CARCASA	CHAPA DE ACERO
PLATINADO	CONTACTO DOBLE
RODAMINETOS	PRIMERA LINEA
AISLAMIENTO	F

CÓDIGO	NOMBRE	FUERZA	VOLTAJE	FASE	REVOL.	REF.	MARCA
440214	MOTOR	1/2HP	110/220V	MONOF	1700RPM	(60.5137.005)	HERCULES
440213	MOTOR	1/4HP	110/220V	MONOF	1700RPM	(60.5137.002)	HERCULES



CERRADO

MOTOR HERCULES BIFASICO

Fabricado con carcasa de aluminio proporcionando alta robustez, menor peso y alta resistencia a agentes corrosivos. Proporcionando reducción en el consumo eléctrico.

TENSION	120/220V
TRABAJO	INDUSTRIAL
CAPACITORES	ARRENQUE Y PERMANENTE
CARCASA	CHAPA DE ACERO
PLATINADO	CONTACTO DOBLE
RODAMINETOS	PRIMERA LINEA
AISLAMIENTO	F

CÓDIGO	NOMBRE	FUERZA	VOLTAJE	FASE	REVOL.	REF.	MARCA
440209	MOTOR	5HP	220V	BIF CER	3500RPM	(60.5183.010)	HERCULES
440218	MOTOR	7.5HP	220V	BIF	1800RPM	(60.5184.012)	HERCULES
440219	MOTOR	7.5HP	220V	BIF	3600RPM	(60.5183.011)	HERCULES
440212	MOTOR	10HP	220V	BIF	1750RPM	(60.5184.013)	HERCULES



CERRADO

MOTOR HERCULES TRIFASICO IP55

Desarrollados para atender las aplicaciones de uso industrial. Motores de alta eficiencia, proporcionando una reducción significativa en el consumo de energía eléctrica.

TENSION	120/380/440V
TRABAJO	INDUSTRIAL
CARCASA	INTECTADA DE ALUMINIO
PLATINADO	CONTACTO DOBLE
RODAMINETOS	PRIMERA LINEA
AISLAMIENTO	F-155°C

CÓDIGO	NOMBRE	CABALLE	FUERZA	FASE	REVOL.	REF.	MARCA
440207	MOTOR	5 HP	380V	TRIF	3500RPM	(60.5128.011)	HERCULES
440208	MOTOR	5 HP	380V	TRIF	1750RPM	(60.5126.011)	HERCULES
440220	MOTOR	7.5 HP	380V	TRIF	1800RPM	(60.5129.713)	HERCULES
440221	MOTOR	7.5 HP	380V	TRIF	3600RPM	(60.5128.713)	HERCULES
440215	MOTOR	10 HP	380V	TRIF	1700RPM	(60.5129.714)	HERCULES



WEG

CÓDIGO	NOMBRE	FUERZA	FASE	VOLTAJE	REVOL.	REF.	MARCA
441201	MOTOR WEG	1HP	MONO F	110/220	1700RPM	14833318	WEG
441225	MOTOR WEG	1HP	MONO F	110/220	3600RPM	10030233	WEG
441202	MOTOR WEG	2HP	MONO F	110/220	1700RPM	14833495	WEG
441209	MOTOR WEG	2HP	MONO F	110/220	3600RPM	14834119	WEG
441203	MOTOR WEG	3HP	MONO F	110/220	3600RPM	14834124	WEG



CÓDIGO	NOMBRE	FUERZA	FASE	VOLTAJE	REVOL.	REF.	MARCA
441208	MOTOR WEG	3HP	MONO F	110/220	1700RPM	11208211	WEG
441211	MOTOR WEG	5HP	BIFASICO	220V	1720RPM	11177088	WEG
441212	MOTOR WEG	5HP	BIFASICO	220V	3600RPM		WEG



CÓDIGO	NOMBRE	FUERZA	FASE	VOLTAJE	REVOL.	REF.	MARCA
441215	MOTOR WEG	3HP	BIFASICO	220V	1800RPM		WEG
440217	MOTOR WEG	5HP	BIFASICO	220V	1800RPM		WEG
441227	MOTOR WEG	5HP	BIFASICO	220V	3600RPM	13228707	WEG
441219	MOTOR WEG	5HP	TRIFASICO	380V	1750RPM	12020980	WEG
441218	MOTOR WEG	5HP	TRIFASICO	380V	3500RPM	12905141	WEG



SAINT-GOBAIN



SAINT-GOBAIN

Disco corte metal

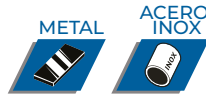

Disco de alto desempeño con seguridad garantizada que permite cortes rápidos, sin rebabas evitando la quema de la pieza con menor fatiga del operario. Aplica en acero inoxidable y aceros en general.



Código	Dimensión	Espesor	Cartón
534304	4 1/2	1/8	25
534416	4 1/2	1/16	25
534716	7	1/16	25
534305	7	1/8	25

Código	Dimensión	Espesor	Cartón
534920	9	5/64	25
534309	12	7/64	10
534142	14	7/64	10

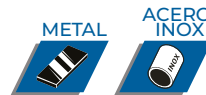

Disco corte metal classic

Permite operaciones de corte prácticas, rápidas y seguras en mercados de consumo y reparaciones ligeras.

Código	Dimensión	Espesor	Cartón
534816	4	1/2	25
534916	7	1/16	25

Disco desbaste metal

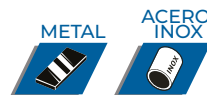

Alto desempeño en desbaste de acero al carbono inoxidable con total seguridad. Para montajes y mantenimientos en los mercados metalmecánicos. Otorgando un nivel de remoción mucho más rápido

Código	Dimensión	Espesor	Cartón
534302	4 1/2	1/4	10
534307	7	1/4	10
534306	9	1/4	10

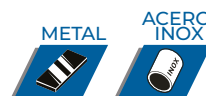

Disco multicorte metal

Disco multifuncional que posibilita el corte hasta 6 tipos diferentes de materiales: Acero, Acero Inox, PVC, Aluminio, Azulejo y Piedra.

Código	Dimensión	Cartón
534143	4	25
534144	7	25

Disco flap classic original

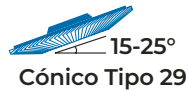

Buena relación precio-calidad en operaciones
Buena relación precio-calidad en operaciones

Código	Dimensión	Grano	Cartón
532021	4 1/2	40	10
532022	4 1/2	60	10
532023	4 1/2	80	10
532025	4 1/2	120	10



Disco pulir



Ideal para el proceso de pulido y acabado final de mármol, granito y piedras decorativas. Respaldo velcro de gran duración. Usar con el soporte original para obtener el máximo en rendimiento

Código	Color	Espesor	Cartón
538050	Azul	50	10
538100	Amarillo	100	10
538200	Tomate	200	10
538400	Rojo	400	10
538800	Verde Osc	800	10

Código	Color	Espesor	Cartón
538150	Verde	1500	10
538300	Café	3000	10
538000	Blanco	Buff Br	10
538001	Negro	Buff Pt	10

Soporte para pulir disco

Código	Dimensión
538500	4"



Lija disco

Utilizados en operaciones de desbaste sobre superficies metálicas. soportan grandes esfuerzos y altas velocidades

Código	Grano	Pulgada	Referencia	Cartón
533200	16	7"	F212	60-10
533201	24	7"	F212	60-10
533202	36	7"	F224/F212	60-10

Disco lija



Utilizados en operaciones de pulido y acabados de superficies metálicas. Soportan grandes esfuerzos y altas velocidades.



Código	Grano	Pulgada	Referencia	Cartón
533040	50	4 1/2"	-	100
533203	50	7"	F227	100-10
533712	60	4 1/2"	-	100
533204	60	7"	F227/F247	100-10
533405	80	4 1/2"	-	100
533205	80	7"	F227/F247	100-10
533206	100	7"	F227	100-10
533622	120	4 1/2"	-	100
533207	120	7"	F227/F247	100-10



Disco rapid blend

Adecuado para eliminar la pintura y barnices en madera.

Código	Revolución	Cartón
532024	Max 12000 RPM	25

Disco rapid strip

Disco de fibra de nylon con grano grueso empleado en los procesos de limpieza en: Acero al carbono, Acero Inox, otorgando un buen nivel de acabado en todo tipos de acero sin calentar ni dañar la superficie de trabajo

Código	Pulgada	Cartón
539200	4 1/2"	10
539201	7"	10



CONSTRUCCIÓN

Disco copa

Para operaciones de desbaste y pulido de mármol y granito. Velocidad de trabajo de 7.250 RPM.

ROSCA 5/8

Código	Grano	Dimensión	Cartón
535024	24	127x51x15.88	2
535036	36	127x51x15.88	2
535060	60	127x51x15.88	2

Código	Grano	Dimensión	Cartón
536080	80	127x51x15.88	2
535100	100	127x51x15.88	2
535120	120	127x51x15.88	2

Disco flap evolution



Disco con respaldo de plástico y doble camada de lija para los procesos de desbastes y acabados más exigentes con menores niveles de vibración. Grano de zirconio premium para aplicaciones industriales.



Código	Dimensión	Grano	Cartón
533358	4 1/2	50	10
537060	4 1/2	60	10

Código	Dimensión	Grano	Cartón
537061	4 1/2	80	10
537120	4 1/2	120	10



PRODUCTO CERTIFICADO EN
SEGURIDAD Y CALIDAD 

Piedra uso general

Para rectificadores y afilados de acero en general, hierro negro, acero de bajo carbono y acero al carbono.

Código	Dimensión	Grano	Cartón
533450	6x3/4	36	3
533451	8x1	36	3
533452	6x3/4	46	3

Piedra widia

Para afilado de herramientas de metal duro (widia), herramientas carburadas. Su corte frío proporciona un afilado preciso.



Código	Dimensión	Grano	Cartón
539020	6x1	100	12
539021	8x1	100	12
539022	6x1	60	3

Código	Dimensión	Grano	Cartón
539023	8x1	60	3
539024	8x1	80	3

Piedra de afilar

Afilado de cuchillos domésticos, industriales y herramientas de corte en general. Camada gruesa para desbastar y camada fina para el afilado



Recomendaciones de uso: 
Refrigerar la pieza para obtener
un afilado rápido y preciso

Código	Dimensión	Cartón
539009	6	50
539003	7	50
539008	8	50

Lija seco A275 Blanca

Hoja de lija con grano de óxido de aluminio Premium con cotado de papel flexible con capas de ESTEARATO de zinc que reducen el empastamiento en operaciones de lijado en seco. Para especialistas de segmentos automotriz y madera

USO



Código	Grano	Referencia	Cartón
533100	80	A275	50
533101	100	A275	50
533102	120	A275	50
533103	150	A275	50
533104	180	A275	50
533105	220	A275	50
533106	240	A275	50

Código	Grano	Referencia	Cartón
533107	280	A275	50
533108	320	A275	50
533109	400	A275	50
533110	500	A275	50
533111	600	A275	50
533112	800	A275	50
533114	1200	A275	50



Lija hierro K226

Producto para remoción de masilla. Ideal para la nivelación de las superficies en los segmentos de automotriz (masilla) y construcción (morteros)

USO



Código	Grano	Referencia	Cartón
531030	30	K246	25
531036	36	K246	25
531040	40	K246	25
531050	50	K246	25

Código	Grano	Referencia	Cartón
531060	60	K246	25
531080	80	K246	25
531100	100	K246	25

Fibra scotch plancha

Hojas de fibra de Nylon ideales para procesos de limpieza y remoción con excelente adaptabilidad a cualquier superficie

Código	Medida	Cartón
539002	260x130	25



Lija rolo tela verde R224

Lija de respaldo con tela y grano en óxido de aluminio utilizada en operaciones de desbaste y acabado en madera, metales y construcción

USO



Código	Rollo	Grano
533374	25mt	36
533375	25mt	50
533371	25mt	60

Código	Rollo	Grano
533370	25mt	80
533373	25mt	100
-	25mt	120



Lija rolo papel S411

Lija con respaldo en una combinación de papel y tela lo que le da una resistencia para aplicaciones pesadas y especializadas en pisos de madera, mármol y granito. Fabrica con granos de carburo de silicio lo que garantiza una excelente resistencia y alto poder de remoción

SUPERFICIES



MADERA MÁRMOL GRANITO

Código	Rollo	Grano
533350	45mt	24
533824	45mt	30
533803	45mt	36

Lija rolo papel S422

Lija especialista para los mercados de pisos de madera y pulido de mármol. Fabricada con un respaldo en una combinación de papel y tela con alta resistencia y granos de carburo de silicio que garantizan un alto poder de remoción.

SUPERFICIES



MADERA MÁRMOL GRANITO



Código	Rollo	Grano
533804	45mt	40
533621	45mt	50
533807	45mt	60

Código	Rollo	Grano
533811	45mt	80
533809	45mt	100
533625	45mt	120

Lija velcro A275



Disco de excelente desempeño con respaldo de papel y soporte Velcro. Fabricado en óxido de aluminio Premium con triple capa de estearato de Zinc que otorgan rendimiento muy superiores a los convencionales.



Código	Grano	Pulgadas	Cartón
533100	80	5"	200
533101	100	5"	200
533102	120	5"	200
533103	150	5"	200
533104	180	5"	200
533105	220	5"	200
533106	240	5"	200

Código	Grano	Pulgadas	Cartón
533107	280	5"	200
533108	320	5"	200
533109	400	5"	200
533110	500	5"	200
533111	600	5"	200
533112	800	5"	200
533114	1200	5"	200

*Perfecta para la limpieza ya que **elimina la oxidación, pinturas y barnices.***



Silicon tekbond transparente verde

La silicona acética Tekbond de construcción es un producto multiuso desarrollado para sellar en diversas superficies con excelente desempeño.



ANTIHONGO

RESISTE DE
-50°C A +150°CRESISTENTE
A LOS RAYOS UVRESISTENTE
A LA HUMEDAD

Código	Contenido	Cartón
539015	256gr	24



Espuma abrasiva teckbond

Es un producto desarrollado para relleno de espacios vacíos, evitando el paso del agua y aire. Se utiliza ampliamente en la instalación de puertas y ventanas, así como en trabajos de arte y restauración. Después de seca, puede ser fácilmente cortada, lijada y pintada para protección y acabado.



PINTABLE



LIJABLE

NO CONTIENE
CFC.
NO DAÑA LA
CAPA DE OZONO

Código	Contenido	Cartón
539017	750ml	12



Clavi líquido MS híbrido gris

Adhesivo flexible recomendable para trabajos con materiales con piedra mármol, concreto y madera



Pintable

Resiste de
-40°C a +120°CResistente
a los Rayos UVResistente
a la humedad

Código	Contenido	Cartón
539013	400g	12



Anillo de cera

Fabrado bajo altos estándares de calidad brindando un sellado hermético entre el inodoro y la tubería de desagüe



Antibacteriano



Fungicida



No se contrae

No se deforma
ni se agrieta

Código	Cartón
533354	10





Tapitex

Somos más que textiles

IMPORTADOS

ALFOMBRA MUSGO



CÓDIGO	ROLLO	REF.	COLOR
220205	18MT	GR01-GR26	ROJO
220206	18MT	GR-27	VERDE PERICO
220202	18MT	GR-30	BROWN
220200	18MT	GR-33	AZUL ELÉCTRICO
220203	18MT	GR-34	GRIS CLARO
220204	18MT	GR-35	NEGRO
220209	18MT	GR-36	VINO
220208	18MT	GR-37	VERDE OSCURO
220210	18MT	GR-39	GRIS OSCURO

PLÁSTICO MICA



CÓDIGO	ANCHO	COLOR	ROLLOS
220080	010MM		150MT
220081	015MM		100MT
220082	020MM		100MT
220083	025MM		100MT
220084	030MM		100MT
220085	040MM		50MT
220086	050MM		50MT
220088	07MM	AZUL	200MT
220087	010MM	AZUL	150MT
220089	015MM	AZUL	100MT



CÓDIGO	NOMBRE	ESPE.	REF.	CARTÓN
223434	CIERRE VERDE MILITAR	14gms	6560-0057	Crt2000-200mt
223427	CIERRE ROJO	14gms	6560-0057	Crt2000-200mt
223435	CIERRE BEIGE	14gms	6560-0057	Crt2000-200mt
223425	CIERRE TURQUEZA	14gms	6560-0057	Crt2000-200mt
223428	CIERRE AZUL ELECTR	14gms	6560-0057	Crt2000-200mt
223421	CIERRE BLANCO	14gms	6560-0057	Crt2000-200mt
223422	CIERRE CAFÉ	14gms	6560-0057	Crt2000-200mt
223424	CIERRE AZUL MARINO	14gms	6560-0057	Crt2000-200mt
223420	CIERRE NEGRO	14gms	6560-0057	Crt2000-200mt
223423	CIERRE GRIS	14gms	6560-0057	Crt2000-200mt



LLAVES CIERRE

CÓDIGO	COLOR	CARTÓN	CAJ.
223430	NEGRO	10000	1000
223433	NIQUEL.	10000	1000
223431	BLANCO	10000	1000
223432	CAFÉ	10000	1000

CIERRES



CÓDIGO	COLOR	ROLLOS
223420	NEGRO	CRT 2000-200MT
223421	BLANCO	CRT 2000-200MT
223422	CAFÉ	CRT 2000-200MT
223423	GRIS	CRT 2000-200MT
223424	AZUL MARINO	CRT 2000-200MT
223425	TURQUEZA	CRT 2000-200MT

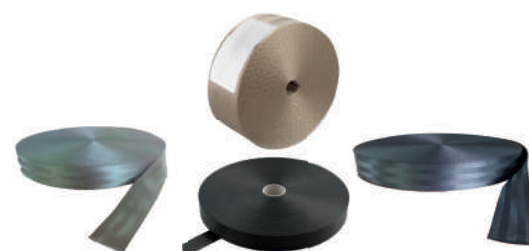

CINTURÓN CARRO

CÓDIGO	COLOR	ROLLO	CARTÓN	MED.
223440	NEGRO	100MT	500MT	500MT
223441	GRIS	100MT	500MT	500MT
223442	BEIGE	100MT	500MT	500MT
223443	HABANO	100MT	50MT	500MT



VELCRO



REATA NEGRA

CÓDIGO	COLOR	PULG.	ANCHO	REF.	ROLLOS
223413	BLANCO	1PG	25MM	6130-6017	CTR500-25MT
223414	CAFÉ	1PG	25MM	6130-3016	CRT500-25MT
223410	NEGRO	1PG	25MM	6130-6017	CRT500-25MT
223411	NEGRO	1-1/2 PG	38MM	6130-6021	CRT300-25MT
223415	BLANCO	1-1/2 PG	38MM	6130-6021	CRT300-25MT
223416	CAFÉ	1-1/2 PG	38MM	6130-3022	CRT300-25MT
223412	NEGRO	2PG	50MM	6130-6024	CRT250-25MT
223417	BLANCO	2PG	50MM	6130-6024	CRT250-25MT
223418	CAFÉ	2PG	50MM	6130-3032	CRT250-25MT

CÓDIGO	ANCHO	REF	CARTÓN
223419	30MM	06/8PpTAPE	1300/50mt
223426	40MM	06/8PpTAPE	1000/50mt

MOQUETAS



227361

MOQUETA CAUCHO

COLOR	NEGRA RAYAS
ANCHO	1.20 MT
ROLLO	15 MT



227380

MOQUETA PVC

COLOR	BOLAS D-GREY
ANCHO	1 MT
ROLLO	15 MT



227362

MOQUETA CAUCHO

COLOR	NEGRA LISA
ANCHO	1.20 MT
ROLLO	15 MT



227381

MOQUETA CAUCHO

COLOR	BOLAS BLACK-NEGRO
ANCHO	1 MT
ROLLO	15 MT



227384

MOQUETA PVC

COLOR	BOLAS NEGRO
ANCHO	2 MT
ROLLO	20 MT

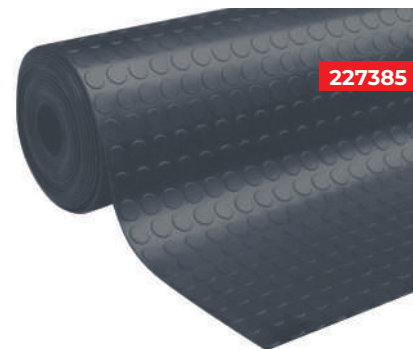

227385

MOQUETA PVC

COLOR	BOLAS GRIS OSCURO
ANCHO	2 MT
ROLLO	20 MT



227386

Mate**MOQUETA CAUCHO**

COLOR	BOLAS NEGRO MATE
ANCHO	1 MT
ROLLO	15 MT



227388

MOQUETA PVC

REF.:	Bolas
COLOR	GRIS CLARO
ANCHO	1 MT
ROLLO	15 MT



220310

ALFOMBRA COCINA - AGUA

COLOR	AMARILLO / GRIS
ANCHO	1.2 MT
ROLLO	15 MT



220311

ALFOMBRA COCINA - AGUA

COLOR	FLORES GRIS
ANCHO	1.2 MT
ROLLO	15 MT



220021

ALFOMBRA CENTRO

REF.:	DJ21
MEDIDA	120X180CM



220050

ALFOMBRAS HL-05

ROLLO	1.20X25 MTS
COLOR	PEMBE FLORES



220051

ALFOMBRAS HL-10

ROLLO	1.20X25 MTS
COLOR	KARAMEL



220052

ALFOMBRAS HL-10

ROLLO	1.20X25 MTS
COLOR	STONE



220053

ALFOMBRAS HL-13

ROLLO	1.20X25 MTS
COLOR	BEJ



220054

ALFOMBRAS HL-15

ROLLO	1.20X25 MTS
COLOR	KAHVE



220055

ALFOMBRAS HL-17

ROLLO	1.20X25 MTS
COLOR	PEMBE HOJAS



220070

ALFOMBRA PREMIUM -01

ROLLO	80CM X 25 MTS
COLOR	CAPUCCINO
TIPO	CAMINO



220071

ALFOMBRA PREMIUM -01

ROLLO	80CM X 25 MTS
COLOR	GREY
TIPO	CAMINO



220072

ALFOMBRA PREMIUM -01

ROLLO	80CM X 25 MTS
COLOR	PUDRA-ROSE
TIPO	CAMINO



220060

ALFOMBRA PREMIUM -04

ROLLO	120CM X 25 MTS
COLOR	CAPUCCINO
TIPO	CAMINO



220061

ALFOMBRA PREMIUM -04

ROLLO	120CM X 25 MTS
COLOR	GREY
TIPO	CAMINO



220062

ALFOMBRA PREMIUM -04

ROLLO	120CM X 25 MTS
COLOR	PUDRA-ROSE
TIPO	CAMINO



CÓDIGO	NOMBRE	MED.	REF.	COLOR	CARTÓN
220008	ALFOMBRA BIENVENIDO	60X90CM	GR-6	ROJO	25
220010	ALFOMBRA BIENVENIDO	60X90CM	GR-8	AZUL	25



ADHESIVO PUBLICITARIO

CÓDIGO	NOMBRE	COLOR	ROLLO
227850	Adhesivo Publicitario	Rojo	010mm 1.22x 50mtrs
227851	Adhesivo Publicitario	Blanco	010mm 1.22x 50mtrs
227852	Adhesivo Publicitario	Amarillo	010mm 1.22x 50mtrs



222305

PAPEL TAPIZ 4

COLOR	ARENA LINO
ESPEJOR	280GR
ANCHO	53CM
CARTÓN	CRT16/R10 MTRS



222306

PAPEL TAPIZ 5

COLOR	RAYAS CAFÉ
ESPEJOR	280GR
ANCHO	53CM
CARTÓN	CRT16/R10 MTRS



222307

PAPEL TAPIZ 6

COLOR	BLANCO
ESPEJOR	280GR
ANCHO	53CM
CARTÓN	CRT16/R10 MTRS



222300

PAPEL TAPIZ 1

COLOR	GRIS
ESPEJOR	420GR
ANCHO	53CM
CARTÓN	CRT12/R10 MTRS



222301

PAPEL TAPIZ 2

COLOR	DORADO
ESPEJOR	420GR
ANCHO	53CM
CARTÓN	CRT12/R10 MTRS



222304

PAPEL TAPIZ 3

COLOR	CAFÉ OSCURO
ESPEJOR	420GR
ANCHO	53CM
CARTÓN	CRT12/R10 MTRS



220020

TATAMI MADERA

COLOR	BEIG
ESPEJOR	12MM
ANCHO	60X60CM
CARTÓN	1.2MT- 4UNID



220027

TATAMI MADERA

COLOR	CAFÉ CLARO
ESPEJOR	12MM
ANCHO	60X60CM
CARTÓN	1.2MT- 4UNID

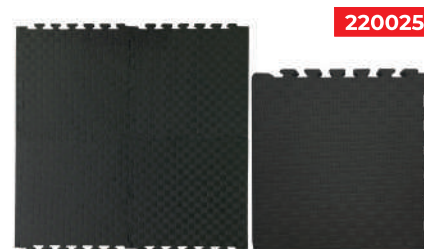

220025

TATAMI NEGRO

COLOR	NEGRO
ESPEJOR	12MM
ANCHO	50X50CM
CARTÓN	10CRT- 4UNID



220029

TATAMI ROJO

COLOR	ROJO
ESPEJOR	12MM
ANCHO	50X50CM
CARTÓN	10CRT- 4UNID

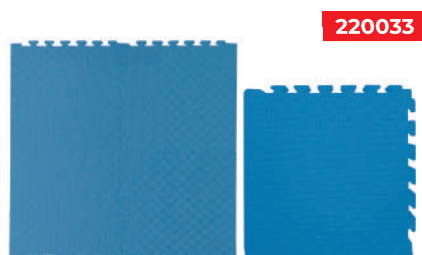

220033

TATAMI AZUL

COLOR	AZUL
ESPEJOR	12MM
ANCHO	50X50CM
CARTÓN	10CRT- 4UNID



220049

TATAMI LILA

COLOR	LILA
ESPEJOR	12MM
ANCHO	50X50CM
CARTÓN	10CRT- 4UNID

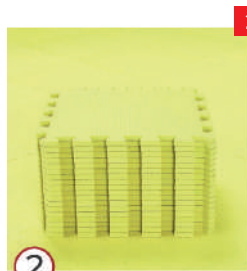

220170

TATAMI AMARILLO

COLOR	AMARILLO
ESPEJOR	12MM
ANCHO	50X50CM
CARTÓN	10CRT- 4UNID



220171

TATAMI NARANJA

COLOR	NARANJA
ESPEJOR	12MM
ANCHO	50X50CM
CARTÓN	10CRT- 4UNID



220025

TATAMI ROJO / AZUL

REF.:	ESP.40
COLOR	ROJO / AZUL
ESPEJOR	2.5 CM
ANCHO	100X100CM
CARTÓN	5UNID



CÓDIGO	NOMBRE	MED.	ESP.	COLOR	CARTÓN
220016	COLCHONETA EJERCICIOS	1.83X0.61MT	10MM	AZÚL	12
220017	COLCHONETA EJERCICIOS	1.83X0.61MT	10MM	VERDE	12
220018	COLCHONETA EJERCICIOS	1.83X0.61MT	10MM	GRIS	12
220035	COLCHONETA EJERCICIOS	1.83X0.61MT	10MM	MORADO	12
220036	COLCHONETA EJERCICIOS	1.83X0.61MT	10MM	CELESTE	12
220037	COLCHONETA EJERCICIOS	1.83X0.61MT	10MM	FUCSIA	12
220038	COLCHONETA EJERCICIOS	1.83X0.61MT	10MM	ROSADO	12
220039	COLCHONETA EJERCICIOS	1.83X0.61MT	10MM	DURAZNO	12

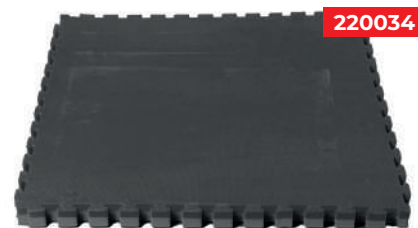

220034

TATAMI NEGRO/GRIS	
COLOR	NEGRO / GRIS
ESPESOR	2.5 CM
ANCHO	100X100CM
CARTÓN	5UNID



CÓDIGO	NOMBRE	MED.	ESP.	COLOR	CARTÓN
220042	COLCHONETA EJERCICIOS	1.83X0.61MT	10MM	NEGRO	10
220043	COLCHONETA EJERCICIOS	1.83X0.61MT	10MM	ROSADO	10
220044	COLCHONETA EJERCICIOS	1.83X0.61MT	10MM	VERDE	10
220045	COLCHONETA EJERCICIOS	1.83X0.61MT	10MM	GRIS	10
220046	COLCHONETA EJERCICIOS	1.83X0.61MT	10MM	AZUL	10
220047	COLCHONETA EJERCICIOS	1.83X0.61MT	10MM	MORADO	10

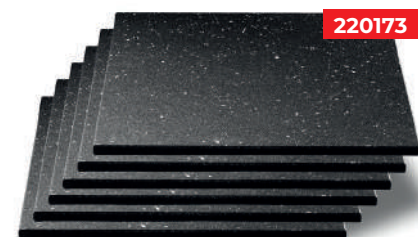

220173

MOQUETA DE ARQUITECTURA	
COLOR	NEGRO
ESPESOR	1T5 CM
ANCHO	100X100CM
CARTÓN	5UNID

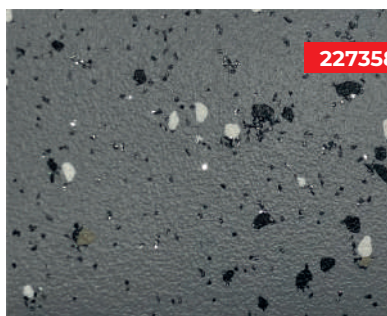

227358



227359



227357

MOQUETA BUS	
REF.:	CANO PLAT-05 CONCRETE
COLOR	GRIS
ANCHO	2MT
ROLLO	20MT

MOQUETA BUS	
REF.:	CANO-11 CORNFLOWER
COLOR	AZUL MEDIO
ANCHO	2MT
ROLLO	20MT

MOQUETA BUS	
REF.:	CANO-13
COLOR	AZUL OSCURO
ANCHO	2MT
ROLLO	20MT



227356

MOQUETA BUS

REF:	CANO-12
COLOR	AZUL CLARO
ANCHO	2MT
ROLLO	20MT



227360

MOQUETA BUS

REF:	CANO-CPLUS15
COLOR	NEGRA
ANCHO	2MT
ROLLO	20MT



223402

CINTA REFLECTIVA

REF:	6801-3007
COLOR	PLATEADA
ANCHO	2.5CM
CARTÓN	2500-50MT



223403

CINTA REFLECTIVA PARA CALOR

REF:	6804-2002
COLOR	PLATEADA
ANCHO	2.5CM
CARTÓN	2500-50MT



223404

CINTA REFLECTIVA

REF:	6808-1008
COLOR	VERDE-PLATEADA
ANCHO	5X1.5CM
CARTÓN	1000-50MT



223401

ELASTICO BLANCO

REF:	6122-0270
MEDIDA	5MM
CARTÓN	9600
ROLLO	4000MT



229208

MASCARILLA PARTICLE

REF:	MOD 004-2
TIPO	KN95
CRT.	1000-20-1
MARCA	BEIXIKANG

**BOTÓN CASQUETE**

CÓDIGO	MEDIDA	REF
223472	30 L	6616-0090
223473	36 L	6616-0092



223474

MAQUINA TRQUELADORA

REF.:	PBM-02 6612-0002
USO	P/CASQUETE BOTÓN

**BOTÓN METÁLICO**

CÓDIGO	MEDIDA	REF
223405	30 L	6605-0112
223406	36 L	6605-0131



229900

TIZA PARA TELA

MEDIDA	70x70MM
CANTIDAD	10 UNIDADES
REF	6927-0019



223468

VELCRO

MEDIDA	100MMx25M
REF	6130-6011



227306

VINIL PESADO

REF.:	WE-A1
TAMAÑO	2X20MT



229600

ADHESIVO PARED

REF.:	Fc-07
TAMAÑO	70X77CM
TIPO	LADRILLO NARANJA



229612

ADHESIVO PARED

REF.:	LM14-4
TAMAÑO	70X70CM
TIPO	ROMBO DORADO



229605

ADHESIVO PARED

REF.:	LM3-7
TAMAÑO	70X77CM
TIPO	LADRILLOS VERDE



229629

ADHESIVO PARED #3

REF.:	#3
TAMAÑO	70X70 CM
TIPO	BLANCO CUADROS



229741

ADHESIVO PARED

REF.:	75-005
TAMAÑO	70X70CM
TIPO	BEIGE

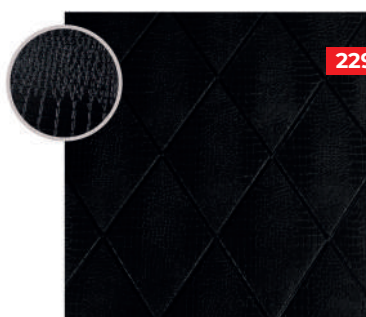

229745

ADHESIVO PARED

REF.:	75-011
TAMAÑO	70X70CM
TIPO	NEGRO



229746

ADHESIVO PARED

REF.:	78-001
TAMAÑO	70X70CM
TIPO	BLANCO

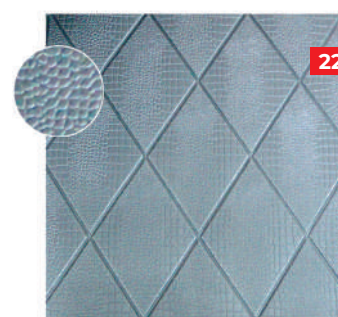

229744

ADHESIVO PARED

REF.:	75-009
TAMAÑO	70X70 CM
TIPO	PLATEADO

MANTEL PVC IMPERMEABLE

137 cm de ancho / ROLLO 50 MTS



Cod: 227805



Cod: 227806



Cod: 227807



Cod: 227808

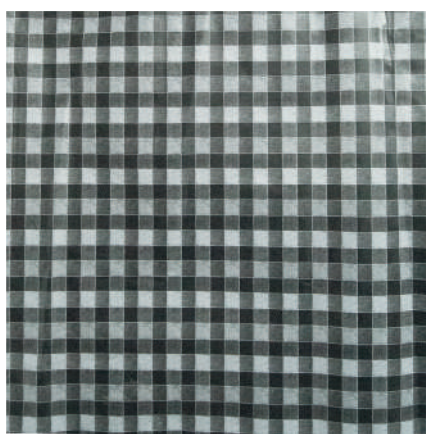

Cod: 227809



Cod: 227810



Cod: 227811

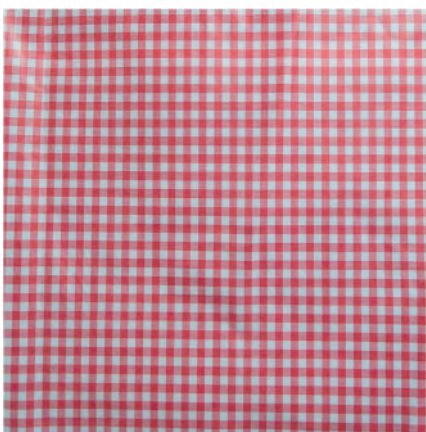

Cod: 227812



Cod: 227813

MANTEL PVC IMPERMEABLE

137 cm de ancho / ROLLO 50 MTS



Cod: 227814



Cod: 227815

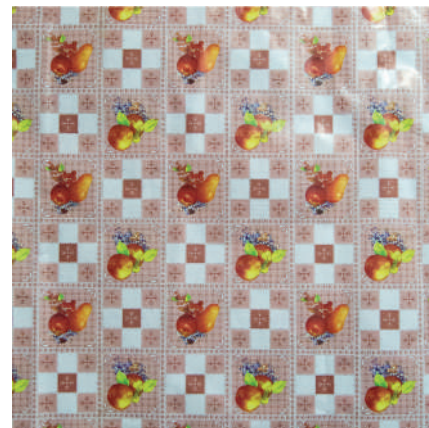

Cod: 227816



Cod: 227817



Cod: 227818



Cod: 227819



Cod: 227820



CÓDIGO	NOMBRE	ROLLO	REF.	COLOR
227830	LONA MOCHILA	1.5M/50MT	8106-0037	NEGRO
227831	LONA MOCHILA	1.5M/50MT	8106-0037	AZUL OSCURO
227832	LONA MOCHILA	1.5M/50 MT	8106-0037	AZUL ELECTRICO
227833	LONA MOCHILA	1.5M/50 MT	8106-0037	BLANCO
227834	LONA MOCHILA	1.5M/50MT	8106-0037	ROJO

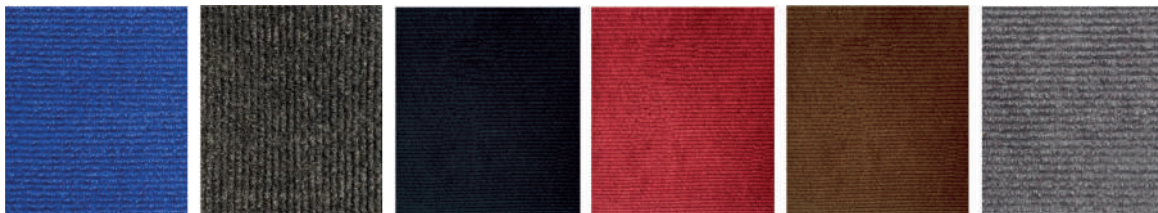

CÓDIGO	NOMBRE	ROLLO	REF.	COLOR
228100	TAPIZÓN	50MT	GR03	AZUL
228101	TAPIZÓN	50MT	GR-14	GRAFITO
228103	TAPIZÓN	50 MT	400GRM	NEGRO
228104	TAPIZÓN	50 MT	400GRM	ROJO
228105	TAPIZÓN	50MT	400GRM	TABACO
228108	TAPIZÓN	50MT	400GRM	GRIS CLARO

228204

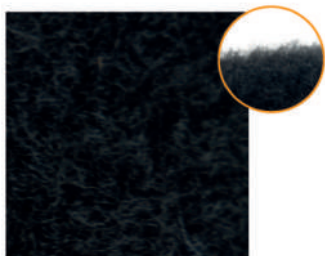
**TAPIZÓN VELOUR**

COLOR	NEGRO
ANCHO	2MT
ROLLO	40MTS
GRAMOS	400
REF	GR19

228201

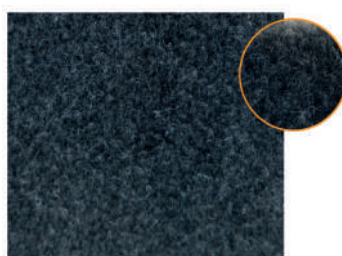
**TAPIZÓN VELOUR**

COLOR	GRAFITO
ANCHO	2MT
ROLLO	45-50MTS
GRAMOS	400
REF	GR19

228205

**TAPIZÓN VELOUR LISO**

COLOR	TABACO
ANCHO	2MT
ROLLO	50MTS
GRAMOS	450
REF	P501

228209

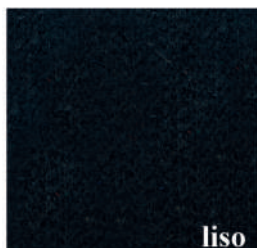
**TAPIZÓN VELOUR LISO**

COLOR	NEGRO
ANCHO	2MT
ROLLO	50MTS
GRAMOS	450
REF	P300

228111

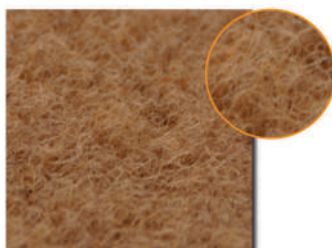
**TAPIZÓN VELOUR**

COLOR	CAMEL
ANCHO	2MT
ROLLO	40MTS
GRAMOS	400
REF	GR15

228200

**TAPIZÓN VELOUR**

COLOR	GRIS
ANCHO	2MT
ROLLO	40MTS
GRAMOS	400
REF	GR09

228208

**TAPIZÓN PARLANTE IMP**

COLOR	GRAFITO
ANCHO	2MT
ROLLO	50MTS
GRAMOS	250
REF	P302

**Saran Negra**

CÓDIGO	MEDIDA	SOMBRA	PESO
227845	2.10X100mt	65%	50gsm
227846	4.20X100mt	65%	50gsm
227847	2.10X100mt	80%	65gsm
227848	4.20X100mt	80%	65gsm

221174

**MALLA NET ANTI-PÁJAROS**

MEDIDA	1.90x150MT
COLOR	NEGRA

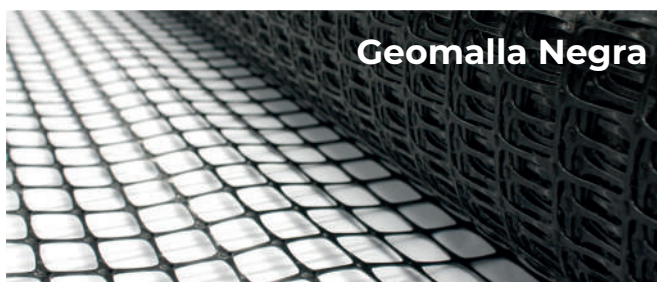
**Geomalla Negra**

CÓDIGO	MEDIDA	ROLLO
220078	2m	50mt
220079	1.5m	50mt



MICROFIBRAS



COROSILES

**VINIL DE PISO****PISO FLOTANTE****BARREDERAS**





TAFETA



VIOTO



DEWALT®



TALADRO 3/8"

REF.	DCD700
VOLTAJE	12V 1.3Ah
CAPACIDAD	10MM-3/8" LITIO
TORQUE MAX	15/24 Nm
VELOCIDAD	0-1.500 RPM
BATERIA	LITHIUM



TALADRO 1/2"

REF.	DW505
MOTOR	6.1A
POTENCIA	700W
GOLPES/MIN	0-46.000GPM
VELOCIDAD	0-2.700RPM



TALADRO 1/2"

REF.	DCD709 D2-D4
VOLTAJE	20V
CAPACIDAD	13MM-1/2"
MARTILLO	0-25.500 GPM
VELOCIDAD	0-2.000 RPM
BATERIA	LITHIUM



TALADRO 1/2"

REF.	DWD024
MOTOR	5.92A
POTENCIA	650W
GOLPES/MIN	0-47.600GPM
VELOCIDAD	0-2.800RPM



ROTO MARTILLO 1"

REF.	D25133K
MOTOR	7A
ENER/IMPAC	2.9 JOULES
IMPACT/MIN	0-5.500
VELOCIDAD	0-1.500RPM



ROTO MARTILLO

REF.	DW25134K
MOTOR	15A
ENER/IMPAC	62 JOULES
ENCASTRE	HEX. 28MM
GOLPES/MIN	0.960 GPM



TALADRO 1/2"

REF.	DW508
MOTOR	-
POTENCIA	800W
GOLPES/MIN	0-51.000GPM
VELOCIDAD	0-3000RPM



AMOLADORA 9"

REF.	DW490
POTENCIA	2.200W - 15A
MOTOR	0-6.500RPM
EMBRAGUE	NO
PROTEC/ABRASIÓN	NO



AMOLADORA 9"

REF.	DW4559
POTENCIA	2.400W - 15A
MOTOR	0-6.500RPM
EMBRAGUE	NO
PROTEC/ABRASIÓN	NO

17051874



ESMERILADORA 7 - 9"

REF.	D28499X
POTENCIA	3.950W - 15A
VELOCIDAD	0-6.000 RPM
EMBRAGUE	ELÉCTRICO
PROTEC/ABRASIÓN	SI

17050150



ESMERILADORA 4-1/2"

REF.	DW4020
MOTOR	7A
POTENCIA	800W
EXTR/POLVO	NO
VELOCIDAD	0-12.000 RPM

17050151



ESMERILADORA 4-1/2"

REF.	DW4120
MOTOR	9A
POTENCIA	900W
EXTR/POLVO	NO
VELOCIDAD	0-12.000 RPM

17051052



ESMERILADORA 7"

REF.	DW4557-B3
POTENCIA	2.400W - 15A
VELOCIDAD	0-8.500RPM
EMBRAGUE	NO
PROTEC/ABRASIÓN	SI

17051017



ESMERILADORA 7"

REF.	DW491B3
POTENCIA	2.200W - 15A
VELOCIDAD	0-8.500 RPM
EMBRAGUE	NO
PROT/ABRASIÓN	NO

17121207



SIERRA CIRCULAR

REF.	DWE560
POTENCIA	1.400W - 12A
VELOCIDAD	0-5.500 RPM
DISCO	7-1/4"
CAP/BISEL	48°

17121223



SIERRA CIRCULAR

REF.	DWE575K
POTENCIA	1.950W - 15A
VELOCIDAD	0-5.200 RPM
DISCO	7-1/4"
CAP/BISEL	57°

17130011



SIERRA CALADORA

REF.	DW300-B3
POTENCIA	500W - 4.5A
CARRERA/MIN	0-3.200 RPM
LONG/CORTE	1"
SOPLADOR POLVO	NO

17130013



SIERRA CALADORA

REF.	DW331K
POTENCIA	700W - 6.5A
CARRERA/MIN	500-3.100 CPM
LONG/CORTE	1"
SOPLADOR POLVO	SI



17130012

SIERRA CALADORA

REF.	DW317K
POTENCIA	660W - 5.5A
CARRERA/MIN	0-3.100 CPM
LONG/CORTE	1"
SOPLADOR POLVO	NO



17231975

RECTIFICADORA

REF.	DW4887
POTENCIA	450W
VELOCIDAD	0-25.000 RPM
PORTA/FRESAS	6MM



17091135

PULIDORA 7"-9"

REF.	DWP849X-B3
POTENCIA	1.250W-12A
VEL/REG	0-3.500 RPM
ROSCA DE EJE	5/8" - 11"



17181470

TROZADORA

REF.	DW28720
MOTOR	13HP - 15A
DIAM/DISCO	14"
VELOCIDAD	0-3.800 RPM



17190121

CORTA LOZA

REF.	DW862W-B3
POTENCIA	1.400W - 10.8A
VELOCIDAD	0-13.000 RPM
PESO	2.97 KG
DISCO	4-7/8"



17210000

ENGALLETADORA

REF.	DW682K
MOTOR	
ENER/IMPAC	
ENCASTRE	
VELOCIDAD	10000 RPM



17060529

INGLETEADORA 10"

REF.	DW713
POTENCIA	1.600W - 15A
DIÁMETRO/DISCO	10"
VELOCIDAD	0-5.000 RPM



17060633

INGLETEADORA 12"

REF.	DWS780S
POTENCIA	1.675W - 15A
DIÁMETRO/DISCO	12"
VELOCIDAD	0-3.800 RPM



17060630

INGLETEADORA 12"

REF.	DW715
POTENCIA	1.600W - 15A
DIÁMETRO/DISCO	12"
VELOCIDAD	0-4.000 RPM



17070065

LIJADORA DE PALMA

REF.	DW26441
POTENCIA	230W - 2.4A
DIÁMETRO/PLIEGO	1/4"
VELOCIDAD	0-14.000 RPM



17071657

LIJADORA ORBITAL

REF.	DWE6421-B3
POTENCIA	280W - 3A
DIÁMETRO/LIJA	5"
VELOCIDAD	0-12.000 RPM



17080063

PISTOLA DE CALOR

REF.	D26411-B3
POTENCIA	1500W
TEMP/AIRE	50-400°C
INDICADOR	PERILLA
TEMPERATURA	REGULABLE



17100056

REBAJADORA

REF.	DW6000
MOTOR	500W - 4.5A
DIÁMETRO/COLECT	1/4"
VELOCIDAD	0-31.000 RPM



17100010

REBAJADORA

REF.	DW616
MOTOR	275W - 11A
CABALLAJE	1-3/4"
VELOCIDAD	0-24.500 RPM



17100026

REBAJADORA

REF.	DW625
MOTOR	15A
CABALLAJE	3HP
DIÁMETRO/COLECT	1/2"-1/4"
VELOCIDAD	0-22.000 RPM



17140558

SIERRA DE MESA

REF.	DWE7470
MOTOR	15A
DIÁMETRO/DISCO	10"
VELOCIDAD	0-5.000 RPM
PROF/CORTE 90°-45°	3"-2-1/2"



17040331

CEPILLO CANTEADOR

REF.	DW734
MOTOR	15A
CAPACIDAD/ANCHO	12-1/2"
VELOCIDAD	0-10.000 RPM
PROF/CORTE 90°-45°	1/8"



DISCO SIERRA CIRCULAR

REF.	DW3178
ØMAYOR	7"
MEDIDAS	1/4" X 5/8"
Nº DIENTES	24



SIERRA PARA MADERA

REF.	DW3130
ØMAYOR	10"
ADAPTADOR	1"-3/4"-5/8"
Nº DIENTES	80



SIERRA PARA MADERA

REF.	DW3120
ØMAYOR	10"
ADAPTADOR	1"-3/4"-5/8"
Nº DIENTES	60



SIERRA PARA MADERA

REF.	DW3140
ØMAYOR	12"
ADAPTADOR	1"-3/4"-5/8"
Nº DIENTES	60



SIERRA PARA ALUMINIO

REF.	DW3230
ØMAYOR	12"-305MM
ADAPTADOR	1"-3/4"-5/8"
Nº DIENTES	80



SIERRA PARA ALUMINIO

REF.	DW3240
ØMAYOR	12"-305MM
ADAPTADOR	1"-3/4"-5/8"
Nº DIENTES	100



DISCO CORTE MADERA

REF.	DWA03150
ØMAYOR	12"
ADAPTADOR	1"-3/4"-5/8"
Nº DIENTES	80





CÓDIGO	NOMBRE	CANT.	REF.	MASTER	MARCA	
0302060	LACA BRILLANTE	1/4	850C	DECORLAC	CRT 6	CONDOR
0302062	LACA BRILLANTE	1/4	801C	DECORLAC	CRT 6	CONDOR
0302063	LACA BRILLANTE	1/4	800C	DECORLAC	CRT 6	CONDOR
0302122	LACA SEMIMATE	1/4	850SBC	DECORLAC	CRT 6	CONDOR
0302124	LACA MATE	1/4	850MC	DECORLAC	CRT 6	CONDOR
0302125	SELLO TRANSP	1/4	840C	DECORLAC	CRT 6	CONDOR
0302127	FONDO BLANCO	1/4	800FC	DECORLAC	CRT 6	CONDOR
0303001	LACA BLANCO MATE	GALÓN	800MC	DECORLAC	CRT 4	CONDOR
0303060	LACA BRILLANTE	GALÓN	850C	DECORLAC	CRT 4	CONDOR
0303062	LACA NEGRO BRILLANTE	GALÓN	801C	DECORLAC	CRT 4	CONDOR
0303063	LACA BLANCO BRILLANTE	GALÓN	800C	DECORLAC	CRT 4	CONDOR
0303069	FONDO BLANCO	GALÓN	800FC	DECORLAC	CRT 4	CONDOR
0303120	LACA MIEL	GALÓN	856C	DECORLAC	CRT 6	CONDOR
0303122	LACA SEMIMATE	GALÓN	850SBC	DECORLAC	CRT	CONDOR
0303124	LACA MATE	GALÓN	850MC	DECORLAC	CRT 4	CONDOR
0303125	SELLO TRANSP	GALÓN	840C-4	DECORLAC	CRT 4	CONDOR
0304001	LACA BLANCO MATE	CANECA	800MC	DECORLAC		CONDOR
0304060	LACA BRILLANTE	CANECA	850C(B80)	DECORLAC		CONDOR
0304063	LACA BLANCO BRILLANTE	CANECA	800C	DECORLAC		CONDOR
0304122	LACA SEMIMATE	CANECA	850SBC	DECORLAC		CONDOR
0304125	LACA MATE	CANECA	850MC(B15-25)	DECORLAC		CONDOR
0304125	SELLO TRANSP	CANECA	840C	DECORLAC		CONDOR
0304127	FONDO BLANCO	CANECA	800FC	DECORLAC		CONDOR



CÓDIGO	NOMBRE	CANT.	MASTER	MARCA
0302050	MASILLA MAS PLAS	1/4	CRT 6	CONDOR
0303050	MASILLA MAS PLAS	GALÓN	CRT 4	CONDOR



PINTURAS
every®
Pasión por el color



LACAS CATALIZADAS AL ÁCIDO

CÓDIGO	NOMBRE	MEDIDA	COLOR	REF.	CAJA
192106	SELLO	1/4	NEGRO	M592	16L
192108	SELLO	1/4	WENGUE	M596U	16L
192113	SELLO	1/4	BLANCO	M593	16L
190206	SELLO	GALÓN	NEGRO	M592G	4L
190208	SELLO	GALÓN	WENGUE	M596G	4L
190213	SELLO	GALÓN	BLANCO	M593G	4L
190306	SELLO	CANECA	NEGRO	M592C	
190308	SELLO	CANECA	WENGUE	M596	
192313	SELLO	CANECA	BLANCO	M593	
194104	LACA	1/4	ROJO INGLÉS	M556U	16L
194113	LACA	1/4	BLANCO BRILLANTE	M518	16L
194117	LACA	1/4	BLANCO MATE	M528	16L
194204	LACA	GALÓN	ROJO INGLÉS	M556G	4L
194213	LACA	GALÓN	BLANCO BRILLANTE	M518G	4L
194217	LACA	GALÓN	BLANCO MATE	M528G	4L
194313	LACA	CANECA	BLANCO BRILLANTE	M518	
194314	LACA	CANECA	BLANCO MATE	M528	



LACAS CATALIZADAS AL ÁCIDO

CÓDIGO	NOMBRE	MEDIDA	COLOR	REF.	CAJA
192112	SELLO	1/4	TRASP	M695U	16L
192212	SELLO	GALÓN	TRASP	M695G	4L
192312	SELLO	CANECA	TRASP	M695C	
195105	LACA	1/4	BRILLANTE	M650U	16L
195109	LACA	1/4	MIEL	M653U	16L
195110	LACA	1/4	CARAMELO	M654U	16L
195111	LACA	1/4	SEMIMATE	M680U	16L
195103	LACA	1/4	MATE	M670U	16L
195203	LACA	GALÓN	MATE	M670G	4L
195205	LACA	GALÓN	BRILLANTE	M650G	4L
195211	LACA	GALÓN	SEMIMATE	M680G	4L
195303	LACA	CANECA	MATE	M670C	
195305	LACA	CANECA	BRILLANTE	M650C	
195311	LACA	CANECA	SEMIMATE	M680C	



NITROCELULOSOS

CÓDIGO	NOMBRE	MEDIDA	REF.	CAJA
191112	SELLO	1/4	M2301	9L
191212	SELLO	GALÓN	M2301	4L
191312	SELLO	CANECA	M2301C	



CÓDIGO	NOMBRE	MEDIDA	COLOR	REF.	CAJA
193102	BARNIZ	1/4	EXTERIOR BRILLO	H100	9L
193202	BARNIZ	GALÓN	BRILLO	H100	4L



STANLEY



312705

FLEXÓMETRO

REF.:	951B-30615X
LARGO	5MT
ANCHO	19MM
CARTÓN	12



312505

FLEXÓMETRO

REF.:	30815 30-085
LARGO	5MT
ANCHO	19MM
CARTÓN	6



312703

FLEXÓMETRO PLÁSTICO

REF.:	951B - 30608
LARGO	3MT
ANCHO	19MM
CARTÓN	12



313262

GRAPA

REF.:	TRA204T
TAMAÑO	1/4
ANCHO	6MM
CARTÓN	1000U/CJ



313266

GRAPA

REF.:	TRA205T
TAMAÑO	5/16
ANCHO	8MM
CARTÓN	1000U/CJ



313263

GRAPA

REF.:	TRA206T
TAMAÑO	3/8
ANCHO	10MM
CARTÓN	1000U/CJ



313162

GRAPA

REF.:	TRA704
TAMAÑO	1/4
ANCHO	6MM
CARTÓN	1000U/CJ



313166

GRAPA

REF.:	TRA705
TAMAÑO	5/16
ANCHO	8MM
CARTÓN	1000U/CJ



313366

GRAPADORA

REF.:	TRA706
TAMAÑO	3/8
ANCHO	10MM
CARTÓN	1000U/CJ



312950

GRAPADORA

REF:	TR250 T/P
TIPO	MANUAL
ANCHO	
CARTÓN	

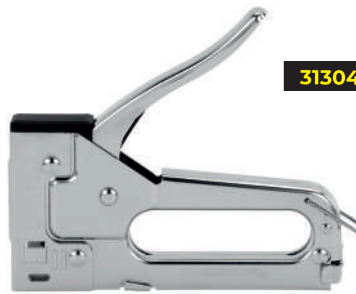

313045

GRAPADORA

REF:	TR45 T/LIVIANO
TIPO	MANUAL
ANCHO	
CARTÓN	



314129

MARTILLO

REF:	6451274
MEDIDA	29MM



314127

MARTILLO

REF:	6451271 18869
MEDIDA	27MM
ANCHO	
CARTÓN	



311300

CUCHILLA METÁLICA

REF:	HE518 10175
COLOR	GRIS - NEGRA



311480

CUCHILLA PLÁSTICA

REF:	10065
LARGO	6" (152 mm)
COLOR	AMARILLO



314510

PISTOLA SILICÓN BARRA

REF:	GR10
PESO	0.16KG
TIPO	
CARTÓN	



314520

PISTOLA SILICÓN BARRA

REF:	GR 20
PESO	0.28 KG
TIPO	
CARTÓN	



316800

JUEGO TIZA Y LINEA

REF:	0447442
MEDIDA	100" /4Oz
ANCHO	
CANT.	2 PIEZAS



NIVEL

REF:	12 42072
LARGO	
ANCHO	
CARTÓN	



SIERRA MESA

REF:	ST1825B3-1801
PULGADAS	10
POTENCIA	1800W
VELOCIDAD	4800RPM



ARCO SIERRA

REF:	20 6120206
MEDIDA	
ANCHO	
COLOR	AMARILLA



FANDELI[®] 

LIJA BANDA

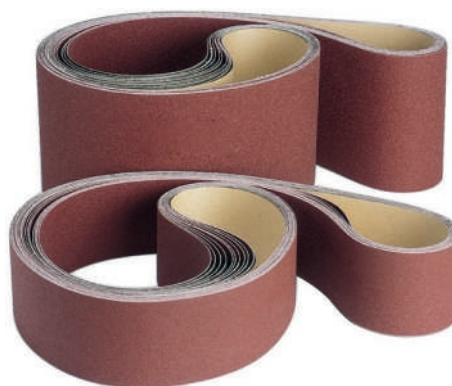

CÓDIGO	NOMBRE	GRANO	MARCA
562202	LIJA BANDA	3X21X60	FANDELI
562201	LIJA BANDA	3X21X80	FANDELI
562203	LIJA BANDA	3X21X100	FANDELI
562204	LIJA BANDA	3X21X120	FANDELI
562062	LIJA BANDA	4X24-60	FANDELI
562063	LIJA BANDA	4X24-80	FANDELI
562060	LIJA BANDA	4X24-100	FANDELI
562061	LIJA BANDA	4X24-120	FANDELI
562045	LIJA BANDA	6X1.25/40 99PG	FANDELI
562046	LIJA BANDA	6X1.25/60 99PG	FANDELI
562047	LIJA BANDA	6X1.25/80 99PG	FANDELI
562048	LIJA BANDA	6X1.25/100 99PG	FANDELI
562049	LIJA BANDA	6X1.25/120 99PG	FANDELI
562058	LIJA BANDA	6X1.25/150 99PG	FANDELI
562059	LIJA BANDA	6X1.25/240 99PG	FANDELI

LIJA AGUA



CÓDIGO	NOMBRE	GRANO	MASTER	MARCA
561080	LIJA AGUA	80	CRT500-50	FANDELI
561100	LIJA AGUA	100	CRT500-50	FANDELI
561120	LIJA AGUA	120	CRT500-50	FANDELI
561150	LIJA AGUA	150	CRT500-50	FANDELI
561180	LIJA AGUA	180	CRT500-50	FANDELI
561220	LIJA AGUA	220	CRT500-50	FANDELI
561240	LIJA AGUA	240	CRT500-50	FANDELI
561280	LIJA AGUA	280	CRT500-50	FANDELI
561320	LIJA AGUA	320	CRT500-50	FANDELI
561360	LIJA AGUA	360	CRT500-50	FANDELI
561400	LIJA AGUA	400	CRT500-50	FANDELI
561500	LIJA AGUA	500	CRT500-50	FANDELI
561600	LIJA AGUA	600	CRT500-50	FANDELI
561900	LIJA AGUA	1000	CRT50-25	FANDELI
561902	LIJA AGUA	1200	CRT50-25	FANDELI

LIJA SECO



CÓDIGO	NOMBRE	GRANO	PULG.	MASTER	MARCA
563080	LIJA VELCRO	80	5PG	CRT400-100	FANDELI
563100	LIJA VELCRO	100	5PG	CRT400-100	FANDELI
563120	LIJA VELCRO	120	5PG	CRT400-100	FANDELI
563150	LIJA VELCRO	150	5PG	CRT400-100	FANDELI
563180	LIJA VELCRO	180	5PG	CRT400-100	FANDELI
563220	LIJA VELCRO	220	5PG	CRT400-100	FANDELI
563240	LIJA VELCRO	240	5PG	CRT400-100	FANDELI
563320	LIJA VELCRO	320	5PG	CRT400-100	FANDELI
563400	LIJA VELCRO	400	5PG	CRT400-100	FANDELI
563600	LIJA VELCRO	600	5PG	CRT400-100	FANDELI

LIJA SECO



CÓDIGO	NOMBRE	GRANO	COLOR	MASTER	MARCA
564080	LIJA SECO	80	AMARILLO	CRT500-50	FANDELI
564100	LIJA SECO	100	AMARILLO	CRT500-50	FANDELI
564120	LIJA SECO	120	AMARILLO	CRT500-50	FANDELI
564150	LIJA SECO	150	AMARILLO	CRT500-50	FANDELI
564180	LIJA SECO	180	AMARILLO	CRT500-50	FANDELI
564220	LIJA SECO	220	AMARILLO	CRT500-50	FANDELI
564240	LIJA SECO	240	AMARILLO	CRT500-50	FANDELI
564280	LIJA SECO	280	AMARILLO	CRT500-50	FANDELI
564320	LIJA SECO	320	AMARILLO	CRT500-50	FANDELI
564400	LIJA SECO	400	AMARILLO	CRT500-50	FANDELI



Fibra Scotch Brite

CÓDIGO	REF.	COLOR	MARCA	MASTER
570802	7447	MARRÓN	FANDELI	R- 40MT

LIJA HIERRO



CÓDIGO	NOMBRE	GRANO	NÚMERO	MASTER	MARCA
567030	LIJA HIERRO	30	4		UNION
567036	LIJA HIERRO	36	3	CRT50	UNION
567050	LIJA HIERRO	50	2-1/2		UNION
567060	LIJA HIERRO	60	2	CRT50	UNION
567080	LIJA HIERRO	80	1-1/2		UNION
567100	LIJA HIERRO	100	1	PQT100	UNION
567120	LIJA HIERRO	120	1/2	CRT50	UNION



NACIONALES





CÓDIGO	NOMBRE	MEDIDA	USO	CARTÓN	MARCA
270200	PLASTICO STRECH	12	COMERCIAL	CRT 16	PTA
270201	PLASTICO STRECH	25	COMERCIAL	CRT 8	PTA
270203	PLASTICO STRECH	50	COMERCIAL	CRT 4	PTA
270207	PLASTICO STRECH	38	COMERCIAL	CRT 4	PTA
270300	PLASTICO STRECH	12	INDUSTRIAL	CRT 16	FLEX
270301	PLASTICO STRECH	25	INDUSTRIAL	CRT 8	FLEX
270302	PLASTICO STRECH	38	INDUSTRIAL	CRT 4	FLEX
270303	PLASTICO STRECH	50	INDUSTRIAL	CRT 4	FLEX
270453	PLASTICO STRECH	50	INDUSTRIAL AZUL	CRT 4	FLEX

Plástico Negro de 1.5 mts: Cada kilo rinde Aprox. 2.5mts.
Plástico Negro de 2mts: Cada kilo rinde Aprox. 2mts.

CÓDIGO	NOMBRE	COLOR	MEDIDA	REND.
270402	PLASTICO	NEGRO	1.5MTS	APROX. 50KL 2.8 RND. X KL
270450	PLASTICO	NEGRO	2MTS	APROX. 45-50 KL. 137 MC APROX. 102 MTS.



CÓDIGO	NOMBRE	COLOR	ANCHO	MEDIDA
270650	PLASTICO INVERNADERO	VERDE	3MTS	ROLLOS 75M
270651	PLASTICO INVERNADERO	VERDE	4MTS	ROLLOS 75M
270652	PLASTICO INVERNADERO	VERDE	6MTS	ROLLOS 50M



CÓDIGO	NOMBRE	COLOR	ANCHO	MEDIDA
271226	PLASTICO	TRANSP	1.5MTS	ROLLOS 50KL



CÓDIGO	NOMBRE	MEDIDA	MASTER
071101	AFRICANO	1/8 (1/24)	CRT160
071401	AFRICANO	1/4	CRT145
071501	AFRICANO	GALÓN	CRT6
071601	AFRICANO	CANECA	



CÓDIGO	NOMBRE	MEDIDA	REF.	MARCA	CARTÓN
070403	COLA BIOPLAST	1/4	51604	BIOPLAST	CRT30
070503	COLA BIOPLAST	GALÓN	51603	BIOPLAST	CRT6
070603	COLA BIOPLAST	CANECA	51602	BIOPLAST	PLT36



CÓDIGO	NOMBRE	MEDIDA	REF.	MARCA	CARTÓN
070202	COLA PLASTICA ESCOLAR	120	50406	ADHEPLAST	CRT108
070402	COLA PLASTICA	1/4	50404	ADHEPLAST	CRT30
070502	COLA PLASTICA	GALÓN	50403	ADHEPLAST	CRT6
070602	COLA PLASTICA	CANECA	50402	ADHEPLAST	PLT36

CÓDIGO	NOMBRE	MEDIDA	REF.:	MASTER
072105	LLAMA ROJA	1/8 1/20	50308	CRT160
072405	LLAMA ROJA	1/4	50306	CRT145
072505	LLAMA ROJA	GALÓN	503303	CRT6





CÓDIGO	NOMBRE	MEDIDA	USO	REF.	MASTER
070404	COLA INDUSTRIAL	1/4	MADERA	50604	CRT30
070504	COLA INDUSTRIAL	GALÓN	MADERA	50603	CRT6
070604	COLA INDUSTRIAL	CANECA	MADERA	50602	PLT36

COLA BIOPARKET	
MEDIDA	CANECA
USO	MADERA
REF.	51673
CARTÓN	PLT36



Para fabricación de muebles de sala

CÓDIGO	NOMBRE	PRESENTACIÓN	CAFETERA	PESO	MASTER	MARCA
071611	PEGAMENTO LÍQUIDO	1/2 CANECA	1.7MM	6.8kg SOPLETE		TAPIX
071612	PEGAMENTO LÍQUIDO	CANECA	1.7MM	14 KG		TAPIX
071411	PEGAMENTO LÍQUIDO	GALÓN	1.7MM		6 UNIDADES	TAPIX
071412	PEGAMENTO LÍQUIDO	1/4	1.7MM		20 UNIDADES	TAPIX



MAYOR RESISTENCIA AL CALOR



APLICACIÓN PISTOLA

Usos:
LINEA AUTOMOTRIZ
TAPICERÍA EN GENERAL
PVC
VINIL
CUERO, ETC.



APLICACIÓN BROCHA

Usos:
LINEA AUTOMOTRIZ
TAPICERÍA EN GENERAL
PVC
VINIL
CUERO, ETC.

CÓDIGO	NOMBRE	PRESENTACIÓN	USO	PESO	DATOS	MARCA
071610	CEMENT CONTACT 148k	CANECA	PISTOLA S/RAPIDO	14 KG	NEOPRENO	TAPIX
071613	CEMENT CONTACT 805k	CANECA	BROCHA S/LENTO	14 KG	Pvc	TAPIX
071614	CEMENT CONTACT 148k	GALÓN	PISTOLA S/RAPIDO	3.78KG	NEOPRENO	TAPIX
071615	CEMENT CONTACT 148k	LITRO	PISTOLA S/RAPIDO	1KG	NEOPRENO	TAPIX
071616	CEMENT CONTACT 805k	GALÓN	BROCHA S/LENTO	3.78KG	Pvc	TAPIX
071617	CEMENT CONTACT 805k	LITRO	BROCHA S/LENTO	1KG	Pvc	TAPIX



CÓDIGO	NOMBRE	PRESENTACIÓN	PESO	MARCA
227124	COLA BLANCA 301C	CANECA	20 KG	TAPIX
227113	COLA BLANCA 302C-301B	GALÓN	4KG	TAPIX



CÓDIGO	NOMBRE	MEDIDA	REF.	CARTÓN
410202	MADEROL LISTO	GALÓN	6MDL0003	CRT 6
410302	MADEROL LISTO	1/4	6MDL0004	CRT12 LIS

CÓDIGO	NOMBRE	MEDIDA	REF.	CARTÓN
410204	REMOVEDOR	GALÓN	8RV0003	CRT4
410304	REMOVEDOR	1/4	8RV0004	CRT6



PREPARACIÓN

1 Gln (Maderol) + 9 Gln (Disolvente)
Rinde 10 galones

1 Lt. (Maderol) + 9 Lts. (Disolvente)
Rinde 10 Litros.

1 Caneca (Maderol) + 9 Caneca (Disolvente)
Rinde 10 Caneca



110103

110101

NOTA: PARA PROVINCIA, EL TANQUE COBRAR FLETE

CÓDIGO	NOMBRE	MEDIDA	REF.	CARTÓN
410203	MADEROL CONCENTRADO	GALÓN	DC003	CRT 6
410303	MADEROL CONCENTRADO	1/4	DC0004	CRT12/6 UN
410103	MADEROL CONCENTRADO	Caneca	DC0002	

DISOLVENTE	
CANT.	1 GALÓN/TANQUE
MARCA	DISTHER



**TINTE 1/4
TINTE GALÓN**

NOTA: PARA PROVINCIA COBRAR FLETE

BROCHAS SOYODA
La brocha que pinta sola!

SOYODA
Brochas

LA ÚNICA ELECCIÓN DEL PINTOR PROFESIONAL
MANGO ERGONÓMICO, LÁMINA REMACHADA PARA MAYOR FIJACIÓN Y MAYOR CANTIDAD DE CERDAS.

CÓDIGO	NOMBRE	MEDIDA	MARCA	MASTER
210510	BROCHA	3/4 PG	SOYODA	CAJ12
210511	BROCHA	1PG	SOYODA	CRT240-12
210512	BROCHA	2PG	SOYODA	CRT120-12
510513	BROCHA	3PG	SOYODA	CRT240-12
210514	BROCHA	4PG	SOYODA	CRT240-12
210515	BROCHA	5PG	SOYODA	CRT240-12
210516	BROCHA	6PG	SOYODA	CAJ12
210517	BROCHA	1-1/2PG	SOYODA	CAJ12
210518	BROCHA	1-1/2PG	SOYODA	CRT240-12
210519	BROCHA	2-1/2PG	SOYODA	CRT240-12



CÓDIGO	NOMBRE	MED.	TIPO	MARCA
210600	RODILLO	4PG	FELPA ACRÍLICA	MAESTRO
210602	RODILLO	9PG	FELPA ACRÍLICA	MAESTRO



ENVASE METÁLICO

CÓDIGO	NOMBRE	MEDIDA	TIPO	REF.:	MASTER
150005	ENVASE	1/4	METALICO ESMALTES	99-130AP	PQ100
150006	ENVASE	1/6	METALICO ESMALTES	65-80AP	PQ150

ENVASE METÁLICO

CÓDIGO	NOMBRE	MEDIDA	TIPO	REF.:	MASTER
150062	ENVASE	1/4	METALICO THINER CAPUCHON	TH83-180R	PQT90
150063	ENVASE	GALÓN	METALICO THINER CAPUCHON	TH165-190CR	PQT36



- Tijera para sastre con corte preciso y filoduradero.
- Cromada y forjada.
- Marca impresa en hoja.
- Ideal para cortar telas gruesas o varias capas a la vez.
- Mangos con dedos de diferentes tamaños para ajustar la mano y ejercer un corte perfecto.

CÓDIGO	NOMBRE	MED.	MARCA	MASTER
219005	TIJERA SASTRE	7"	INDUSTRIAL	CRT12
219004	TIJERA SASTRE	8"	INDUSTRIAL	CRT12
219002	TIJERA SASTRE	9"	INDUSTRIAL	CRT12
219003	TIJERA SASTRE	10"	INDUSTRIAL	CRT12



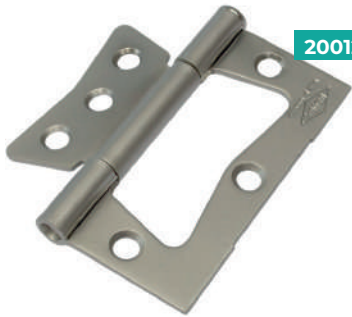

200120

BISAGRA OMEGA

REF.:	IND0066 SN
USO	P/PUERTA
CARTÓN	8-3
MARCA	INDUMA



181506016

ESPONJA

MEDIDA	15 X 15 X 10
USO	MULTIUSOS
COLOR	GRIS
MASTER	PQT250-10



015024

PISTOLA PARA SILICÓN

REF.:	1200
TIPO:	PLÁSTICO
CARTÓN	50



CÓDIGO	NOMBRE	MEDIDA	CABEZA	PESO	REF.	MARCA
458388	CLAVOS IDEAL	3/4X17	C/C	10KLS	20-150 188388	IDEAL
458394	CLAVOS IDEAL	3/4X19	S/C	10KLS	20-110	IDEAL
458398	CLAVOS IDEAL	1X16	C/C	25KLS	25-170 188398	IDEAL
458402	CLAVOS IDEAL	1X18	S/C	25KLS	25-125 188402	IDEAL
458407	CLAVOS IDEAL	1-1/2X14	C/C	25KLS	40-125 188407	IDEAL
458408	CLAVOS IDEAL	2X12	C/C	25KLS	50-280 188408	IDEAL
458420	CLAVOS IDEAL	2X14	S/C	25KLS	50-215 188408	IDEAL
458411	CLAVOS IDEAL	3X9	C/C	25KLS	75-3.80 188411	IDEAL
458413	CLAVOS IDEAL	4X6	C/C	25KLS	100-5.20 188413	IDEAL
458414	CLAVOS IDEAL	5X5	C/C	25KLS	125-5.60	IDEAL
458415	CLAVOS IDEAL	6X4	C/C	25KLS	150-6.10 188415	IDEAL



120401

SAQUILLO

REF.:	
COLOR	VERDE
ANCHO	1.90 MT
ROLLO	100 MT



120402

SAQUILLO 2 / PELIGRO NO PASE

REF.:	
COLOR	VERDE/AMARILLO
ANCHO	2MT
ROLLO	100MT



120403

SAQUILLO 2.5 RAYAS

REF.:	
COLOR	VARIOS COLORES
ANCHO	2.50 MT
ROLLO	100 MT

Fortex CLÁSICO



CÓDIGO	NOMBRE	MEDIDA	ROLLO	MARCA
120301	CABO FORTEX clásico	3/16	ROLLO 16-20 KILOS	FORTEX
120302	CABO FORTEX clásico	1/4	ROLLO 16-20 KILOS	FORTEX
120303	CABO FORTEX clásico	3/8	ROLLO 16-20 KILOS	FORTEX
120304	CABO FORTEX clásico	5/16	ROLLO 16-20 KILOS	FORTEX
120305	CABO FORTEX clásico	1/2	ROLLO 16-20 KILOS	FORTEX
120306	CABO FORTEX clásico	3/4	ROLLO 16-20 KILOS	FORTEX
120307	CABO FORTEX clásico	7/16	ROLLO 16-20 KILOS	FORTEX
120308	CABO FORTEX clásico	5/8	ROLLO 16-20 KILOS	FORTEX
120309	CABO FORTEX clásico	1"	ROLLO 16-20 KILOS	FORTEX
120310	CABO FORTEX clásico	7/8	ROLLO 16-20 KILOS	FORTEX
120311	CABO FORTEX clásico	9/16	ROLLO 16-20 KILOS	FORTEX

MEDIDA	DIAMETRO mm	RENDIMIENTO mts/kg(+/- 10%)	RESISTENCIA kgs/fza(+/- 5%)
1H	1	1100	32,73
2H	2,4	556	64,75
3H	2,8	333	108,11
4H	3,3	263	136,88
1/8"	3,2	212	169,20
5/32"	4	166	195,18
3/16"	4,8	106	305,66
1/4"	6,3	51,3	631,58
5/16"	7,9	33,2	975,91
3/8"	9,5	24,3	1332,90
7/16"	11,1	16,3	1987,73
1/2"	12,7	12,4	2612,90
9/16"	14,3	10,3	3145,50
5/8"	15,9	7,5	4320,00
3/4"	19	6,1	5310,90
7/8"	22,2	5,1	6352,20
1"	25,4	3,3	9818,10

Fortex Clásico es nuestra marca líder elaborada con materias primas importadas de primera calidad. La fusión de estos recursos nos ha permitido ofrecer cabos y piolas de extraordinarias características técnicas, insuperables en calidad, resistencia y duración.

- Cabo Virgen de Polipropileno PP
- Torsiones: Media, Rígido, Semi Rígido.
- Distintivo color rojo
- Flota en el agua
- Presentaciones:
 - Piolas: Bobinas de 5Kg
 - Cabos: 17 Kg
 - Colores: Verde, Azul, Rojo, Amarillo, Natural.



CÓDIGO	NOMBRE	MEDIDA	ROLLO
120112	CABO FORTEx ECOLÓGICO	FINO 2H	ROLLO 5-7 KILOS
120113	CABO FORTEx ECOLÓGICO	FINO 3H	ROLLO 5-7 KILOS
120114	CABO FORTEx ECOLÓGICO	FINO 4H	ROLLO 5-7 KILOS
120121	CABO FORTEx ECOLÓGICO	FINO 1H	ROLLO 4.5-4.8 KILOS
120201	CABO FORTEx ECOLÓGICO	3/16	ROLLO 16-20 KILOS
120202	CABO FORTEx ECOLÓGICO	1/4	ROLLO 16-20 KILOS
120203	CABO FORTEx ECOLÓGICO	5/16	ROLLO 16-20 KILOS
120204	CABO FORTEx ECOLÓGICO	3/8	ROLLO 16-20 KILOS
120205	CABO FORTEx ECOLÓGICO	1/2	ROLLO 16-20 KILOS
120206	CABO FORTEx ECOLÓGICO	5/8	ROLLO 16-20 KILOS
120207	CABO FORTEx ECOLÓGICO	3/4	ROLLO 16-20 KILOS
120208	CABO FORTEx ECOLÓGICO	7/16	ROLLO 16-20 KILOS
120209	CABO FORTEx ECOLÓGICO	1"	ROLLO 16-20 KILOS
120210	CABO FORTEx ECOLÓGICO	7/8	ROLLO 16-20 KILOS
120211	CABO FORTEx ECOLÓGICO	9/16	ROLLO 16-20 KILOS

MEDIDA	DIAMETRO mm	RENDIMIENTO mts/kg(+/- 10%)	RESISTENCIA kgs/fza(+/- 5%)
1H17	2,3	500	41
1H21	2,2	429	50
1H25	2,5	360	60
1H30	3	280	75
1H	1	1100	20
2H	2,4	556	40
3H	2,8	333	65
4H	3,3	263	85
1/8"	3,2	212	101,52
5/32"	4	166	117,11
3/16"	4,8	106	183,39
1/4"	6,3	51,3	378,95
5/16"	7,9	33,2	585,54
3/8"	9,5	24,3	799,74
7/16"	11,1	16,3	1192,64
1/2"	12,7	12,4	1567,74
9/16"	14,3	10,3	1887,30
5/8"	15,9	7,5	2592,00
3/4"	19	6,1	3186,54
7/8"	22,2	5,1	3811,32
1"	25,4	3,3	5890,86

■ Ecológico tiene de base materiales reciclados, contribuyendo a la preservación de la naturaleza y el planeta, y ofreciendo productos más económicos para el uso popular de cabos y piolas. Formulado con diferentes y selectos materiales reciclados, hacen que nuestros tonos y atributos sean superiores a otros cabos en el mercado y a precios competitivos.

- Cabo Reprocesado de Polipropileno PP
- Torsiones: Media, con / sin Fibrilizar
- Flota en el agua
- Presentaciones:
 - Piolas: Bobinas de 5Kg
 - Cabos: 17 Kg
 - Colores: Verde, Azul, Rojo, Amarillo, Naranja, Negro
 - Se reconoce por la pinta de color amarillo



PLAFÓN ABIERTO

CÓD.	MED.	COLOR	REF.
360515	3/4	CAFÉ	
360516	1PG	CAFÉ	
360524	1/2	DORADO	
360525	3/4	DORADO	C031D
360526	1PG	DORADO	C031E



PLAFÓN CERRADO

CÓD.	MED.	COLOR	REF.
360615	3/4	CAFÉ	
360616	1PG	CAFÉ	
360624	1/2	DORADO	
360625	3/4	DORADO	C6222
360626	1PG	DORADO	



TERMINAL

CÓD.	MED.	COLOR	REF.
361015	3/4	CAFÉ	
361016	1PG	CAFÉ	
361024	1/2	DORADO	CO313
361025	3/4	DORADO	CO314
361026	1PG	DORADO	CO315

NOTA: PARA PROVINCIA, COBRAR FLETE

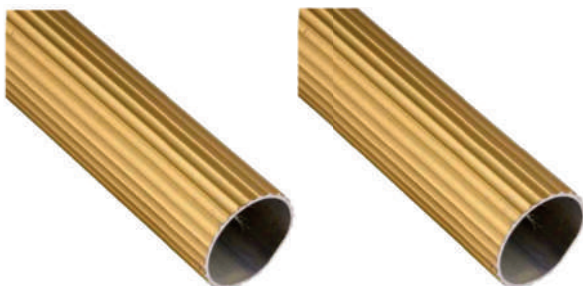

CÓDIGO	NOMBRE	MEDIDA	COLOR	REF.
361124	TUBO CORTINA	12MM 1/2	DORADO	COL0073
361122	TUBO CORTINA	19MM 3/4X6M	DORADO	COL0072
361123	TUBO CORTINA	25MM 1PGX6M	DORADO	COL0071
361132	TUBO CORTINA	19MM 3/4X6.40M	BRONCE	
361136	TUBO CORTINA	25MM 1PGX6.40M	BRONCE	

ARGOLLA



CÓDIGO	MED.	COLOR	REF.	CAJA
360116	1PG	CAFÉ		9L
360126	1PG	DORADO	CO33F	4L



SOPORTE PARED

CÓDIGO	MED.	COLOR	REF.
360915	3/4	CAFÉ	
360916	1PG	CAFÉ	
360925	3/4	DORADO	C035F
360926	1PG	DORADO	C036K



SOPORTE DOBLE

CÓDIGO	MEDIDA	COLOR	REF.
360815	3/4	CAFÉ	
360816	1PG	CAFÉ	
360824	1/2	DORADO	C0573
360825	3/4	DORADO	C0571
360826	1PG	DORADO	C0561



COCINETA POMPEYA 4Q 550990

COCINETA

QUEMADORES:	4
MODELO	POMPEYA
TIPO	GAS
MARCA	KOMBO



390902

DUCHA AUTOMÁTICA

REF:	CD2020
MODELO	SANTORINI
VOLTAJE	110V
MARCA	TERMOPLASTIC



390950

DUCHA AUTOMÁTICA

REF:	CS620
MODELO	AFRODITA SALÓN DE BELLEZA
VOLTAJE	110V
MARCA	TERMOPLASTIC



390960

DUCHA AUTOMÁTICA

REF:	CD680
MODELO	FENIX
VOLTAJE	220V
MARCA	TERMOPLASTIC



383478

GAFAS REFORZADAS

REF:	ABRO
COLOR	TRANSPARENTE
CANTIDAD	72



151000

REGATÓN

MEDIDA	15mm
COLOR	NEGRO



Armor

BOTÍN CUERO

386639	TALL 37
386640	TALL 39
386641	TALL 40
386642	TALL 41
386643	TALL 42
386648	TALL 38
386941	TALL 36



151302

VETEADOR

MEDIDA	4 PULG
REF.	V2015

Es un herramienta de goma ideal para imitar las vetas y los nudos de la madera. Es de fácil utilización y reutilizable y la limpieza se debe realizar con agua o disolvente, dependiendo el tipo del producto que hayas usado



151301

VETEADOR

MEDIDA	3 PULG
REF.	V2015

Es un herramienta de goma ideal para imitar las vetas y los nudos de la madera. Es de fácil utilización y reutilizable y la limpieza se debe realizar con agua o disolvente, dependiendo el tipo del producto que hayas usado



Malla Hexagonal

CÓDIGO	APER.	MEDIDA	DIAM.	CAL.
150700	3/4"	1mx30m	0,7mm	22
150719	3/4"	1,5mx30m	0,7mm	22
150720	3/4"	50cmx100m	0,64mm	22

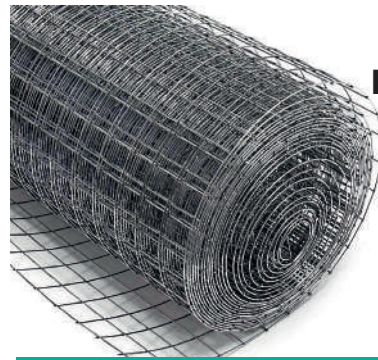

Malla Electrosoldada

CÓDIGO	APER.	MEDIDA	DIAM.	CAL.
150715	2x1/2"	1,5mx30m	1,65mm	16
150716	2x1/2"	76cmx30m	1,45mm	16
150717	2x1/2"	1mx30m	1,65mm	16



Malla Galvanizada

CÓDIGO	APER.	MEDIDA	ESPESOR	CAL.
150702	2"	1,5mx20m	2,3	13
150705	2"	2mx20m	2,3	13

Grapa acero kawaguchi



CRT300-CJ10

CÓDIGO	MEDIDA
370056	1/2"
372050	1"

CÓDIGO	NOMBRE	MEDIDA
510005	TACO FISHER	F-5 FUNDA 3000-500
510006	TACO FISHER	F-6 FUNDA 2000-500
510008	TACO FISHER	F-8 FUNDA 1000-200
510010	TACO FISHER	F-10 FUNDA 500-100
510106	TACO F HSL	F-6 FUNDA 2000-500
510108	TACO F HSL	F-8 FUNDA 1000-200
510110	TACO F HSL	F-10 FUNDA 500-100



TAMAÑO	LONGITUD	BROCA	TORNILLO	CONCRETO	BLOQUE	PIEDRA POMEZ	LADRILLO
F-5	1" 26mm	3/16" 5mm	#7-8	300	200	100	80
F-6	1-3/16" 30mm	1/4" 6mm	#8-10	500	400	300	140
F-8	1-5/8" 40mm	5/16" 8mm	#10-12	800	600	500	200
F-10	2" 50mm	3/8" 10mm	#14 5/16"	1000	800	700	400
F-12	2-3/8" 60mm	1/2" 12mm	3/8"	1200	1000	800	600



152502

IDEAL PARA EL USO DE LA AGRICULTURA, RIEGO. SE PUEDE USAR PARA LA INDUSTRIA DE LA ELECTRICIDAD, CABLEADO.

MANGUERA POLITUBO

DIAME	1/2
PRESIÓN	60PSI
ROLLO	100MTS
MARCA	AGROTEX



144688

ALMOHADA

REF:	AL014
MEDIDA	50X70CM
MODELO	SLEEPTec
MARCA	FIBRATEX



320413

PADDING

COLOR	GRIS
ANCHO	2MT
ROLLO	30MT
CAPA	400GR



144600

ALMOHADA

REF:	AL005
MEDIDA	50X70CM
CARTÓN	PQT25
MARCA	FIBRATEX

CÓDIGO	NOMBRE	ESPESOR	MARCA
280015	PLUMÓN RELLENO	50-KL S-1	CONFORT
280020	PLUMÓN RELLENO	PQT25KL-1	SONN SAMS
280005	PLUMÓN RELLENO	25KL-1	FIBRATEX



CÓDIGO	NOMBRE	ESPESOR	ROLLO	ANCHO	REF.	MARCA
280000	PLUMÓN	1CM	50MT	240CM	ST1	FIBRATEX
280004	PLUMÓN	2CM	40MT	240CM	ST2	FIBRATEX
280001	PLUMÓN	2.5CM	30MT	240CM	ST2.5	FIBRATEX
280002	PLUMÓN	3CM	24MT	240CM	ST3	FIBRATEX
280010	PLUMÓN	1CM	60MT	240CM	PL1	CONFORT
280014	PLUMÓN	2CM	40MT	240CM	PL2	CONFORT
280012	PLUMÓN	3CM	30MT	240CM	PL3	CONFORT



CHAIDE
SUEÑA CON UN MUNDO MEJOR



CÓDIGO	NOMBRE	MEDIDA	REF.
141494	Colchon Restonic 2-1/2p	160x200x029	304 Excellence



COLCHON POCKET

Tela con tratamiento antiacaros, antihongos y antibacterias
Panel de resorte que impide la transmisión de movimiento evitando interrupción de sueño

Tecnología desarrollada para nuna dar la vuelta al colchón, máximo confort y calidad en un solo lado

Espuma perfilada que permite la circulación aire y mayor ventilación

CÓDIGO	MEDIDA	REF.
141491	2-1/2 Plz	Beige - Rayas azul/gris
141290	2 Plz	Beige - Rayas azul/gris
141592	3 Plz	Beige - Rayas azul/gris

COLCHÓN CONTINENTAL

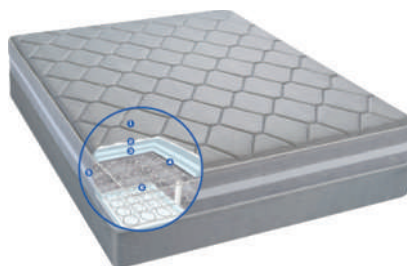

CÓDIGO	MEDIDA	REF.
141151	1-1/2 PLZ 105X27CM	156 BEIGE NF AC
141152	1-1/2 PLZ 105X27CM	1526 GRIS NF-AC
141166	1-1/2PLZ 105X29CM	146 HJ-AZUL
141255	2PLZ 135X27CM	BEIGE FB 224I
141260	2PLZ 135X29CM	GRIS 148
141286	2PLZ 135X30	GR PTW AC 179
141460	2-1/2PLZ 160X29CM	GRIS 152
141486	2-1/2PLZ 160X30CM	GR PTW-AC 181
141256	2-1/2PLZ 160X27CM	BEIGE FB 2243
141237	3PLZ 200X27CM	FB 2244
141560	3PLZ 200X29CM	154 GRIS
141123	3PLZ 200X30CM	PT 182

COLCHÓN ORTOPÉDICO



CÓDIGO	MEDIDA	REF.
141103	1-1/2 PLZ	NF 650
141210	2 PLZ	N/F AC 652
141403	2-1/2 PLZ	N/F 654
141528	3 PLZ	655 PTW AC



COLCHÓN IMPERIAL

CÓDIGO	MEDIDA	REF.
141119	1-1/2 PLZ 105X23CM	615 FR-VINO
141219	2 PLZ 135X23CM	TRADICIONAL FR-VINO
141221	2 PLZ 135X27	1780 HJ-BG



GRATIS
ALM AURORA
COLCHON
ZAFIRO

CÓDIGO	MEDIDA	REF.
141170	1-1/2p 105x190x023	4462 Azul
141270	2 Plz 135x23	4463I Azul
145379	1 Plz 90x23	4460 Azul

DREAMER



Memory foam



Nivel de confort (suave)



Garantía 10



Protección Antibacteria

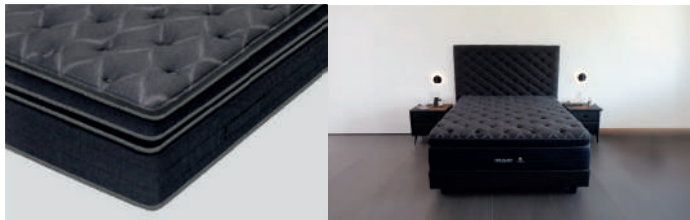

2 plazas: 135 cm
x 190 cm

2 ½ Plazas: 160 cm
x 200

3 plazas: 200 cm
x 200 cm

ESTRUCTURA INTERNA

1. Tela con tratamiento BioShield, previene alergias y te brinda un descanso placentero sin preocupaciones.
2. Tela con tratamiento Adaptive, reduce la humedad generando un entorno fresco y seco.
3. Acolchado con tecnología Tack & Jump.
4. Box top compuesto por: láminas de espuma convoluted y fibra de alta resiliencia para mayor suavidad.
5. Memory Foam con partículas de Gel Infused, para mantener la temperatura ideal del colchón, contribuyendo a un ambiente fresco y confortable.
6. Lámina de látex que se adapta a la forma del cuerpo sin crear puntos de presión.
7. Espuma de alta densidad que contribuye a una mejor adaptabilidad.
8. Espuma de soporte de alta densidad.
9. Pocket coil dual, doble panel de resortes enfundados individualmente que evita la transmisión de movimiento y ofrece mayor confort y adaptabilidad.
10. Marco de espuma (Foam Encasement) que refuerza los bordes laterales del colchón.
11. Resistente plancha de espuma.

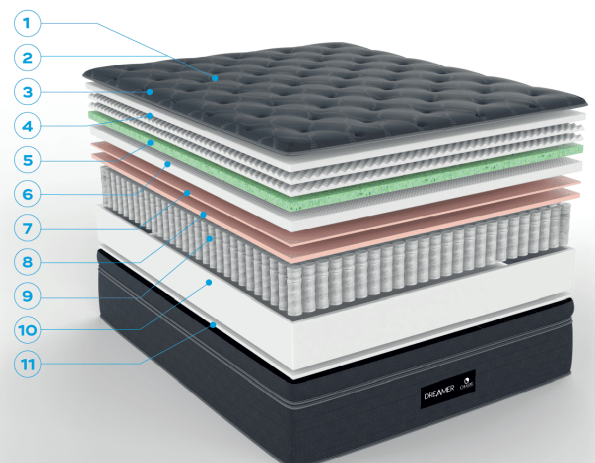

Grand PALACE



Memory foam



Nivel de confort (suave)



Garantía 10



Protección Antibacteria



2 plazas: 135 cm
x 190 cm

2 ½ Plazas: 160 cm
x 200

3 plazas: 200 cm
x 200 cm

ESTRUCTURA INTERNA

1. Tela Fera Ice, libera rápidamente la humedad de la superficie ocasionada por el calor corporal, manteniéndola fresca y seca. Tecnología Antiviral y Antibacterial.
2. Diseño de acolchado con tecnología Tack & Jump.
3. Acolchado con espuma convoluta de alta resiliencia que brinda mayor aireación y confort.
4. Box Top compuesto por Memory Foam y planchas de espuma de alta densidad.
5. Espuma de soporte de alta densidad.
6. Resistente lámina aislante.
7. Panel de resortes de acero de alto carbono.
8. Marco de espuma (Foam Encasement) que refuerza los bordes laterales del colchón.
9. Resistente plancha de espuma.

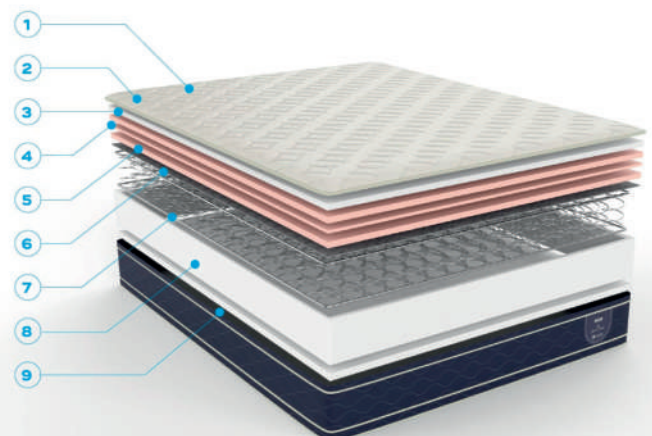

Grand HOTEL



Tela retardante
de flama



Nivel de
confort (intermedio)



Garantía 10



Protección
Antibacteria



2 plazas: 135 cm
x 190 cm

2 ½ Plazas: 160 cm
x 200

3 plazas: 200 cm
x 200 cm

ESTRUCTURA INTERNA

1. Tela Jacquard europea con Tratamiento Retardante de Flama con tecnología Antiviral + Antibacterial.
2. Acolchado profundo con espumas de alta resiliencia que brinda máximo confort.
3. Espuma de soporte de alta densidad.
4. Resistente lámina aislante.
5. Panel de resortes de acero de alto carbono.
6. Marco de espuma (Foam Encasement) que refuerza los bordes laterales del colchón.

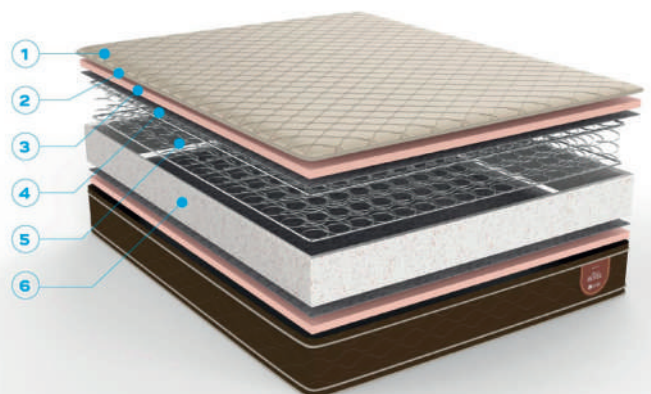

Dream Box



Fácil de transportar



Nivel de confort (firme)



Garantía 10



Tela antiácaros



2 plazas: 135 cm
x 190 cm

2 ½ Plazas: 160 cm
x 200

3 plazas: 200 cm
x 200 cm

ESTRUCTURA INTERNA

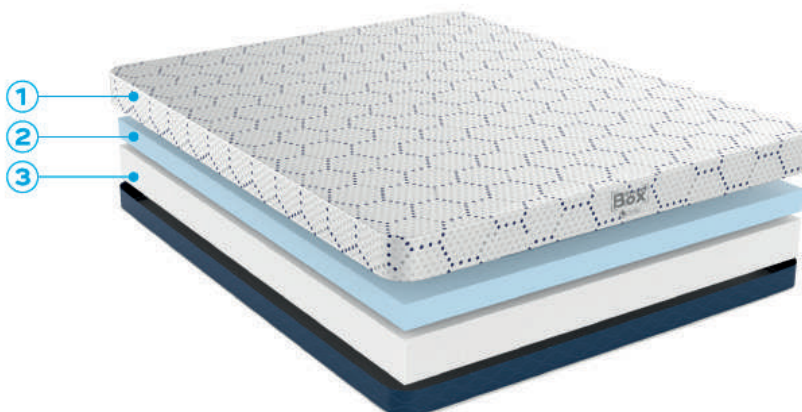

1. Tela de textura suave, con tratamiento antiácaros y antibacterias.
2. Espuma Soft para proporcionar comodidad y confort
3. Espuma de soporte de alta calidad.



CÓDIGO	MEDIDA	
141102	2-1/2 PLZ ZAFIRO SURTIDO	1616
141693	2 PLZ ZAFIRO SURTIDO	1544



CÓDIGO	DESCRIPCIÓN
147697	TOALLA CHAIDE KIT X 2 CUERPO Y MANOS VARIOS COLORES



CÓDIGO	MEDIDA	REF.
430110	2 PLZ ZAFIRO	1763
430111	2-1/2 PLZ ZAFIRO	SURTIDO 1604
431203	1/1/2 PLZ ZAFIRO	SURTIDO 1762



CÓDIGO	MEDIDA	REF.
143096	60x38	MF1342



CÓDIGO	MEDIDA	REF.
143194	60x40x14	RESTONIC MF 939
143195	60x40x14	RESTONIC MF AROMA 1169
143294	65x45x13	RESTONIC MF 940



CÓDIGO	MEDIDA	MODELO
143698	50x70	RUBÍ



Tapitex

Somos más que textiles



Matriz: Av. Hurtado de Mendoza 2-17
y José Joaquín de Olmedo
Cel: 096 798 0333

Sucursal: Av. de las Américas y Huacas
Cel: 099 448 7328

Parque Industrial: Av. del Toril y Carapungo 2
Cel: 099 446 9522